

EN	Ophthalmology
DE	Ophthalmologie
ES	Oftalmología
FR	Ophtalmologie
IT	Oftalmologia

Page 651 to 681

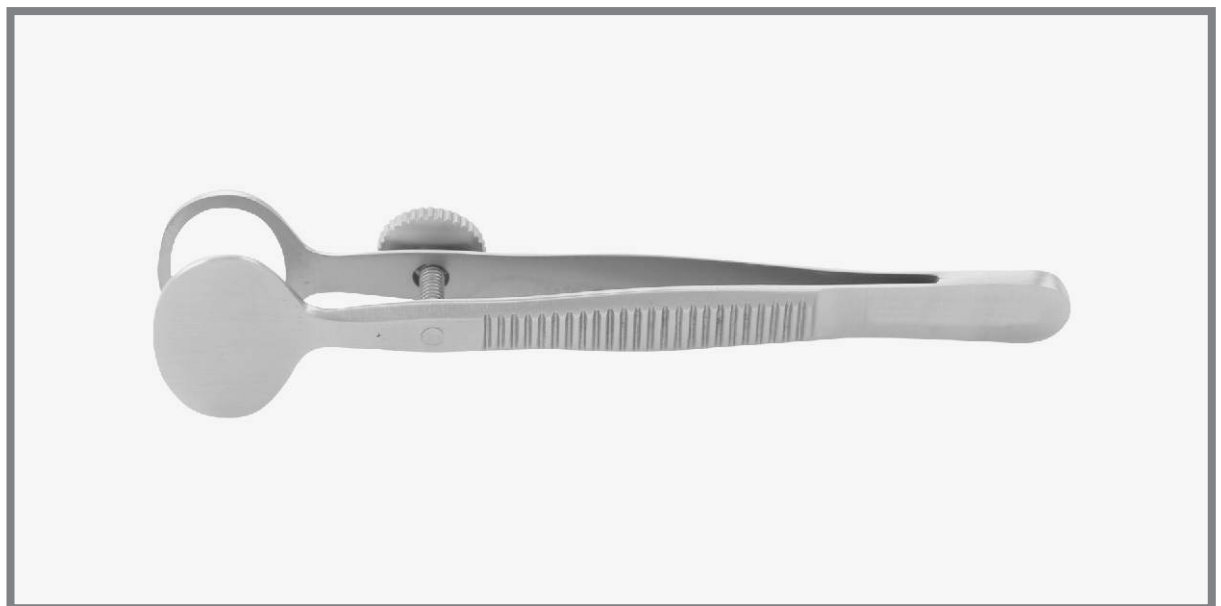

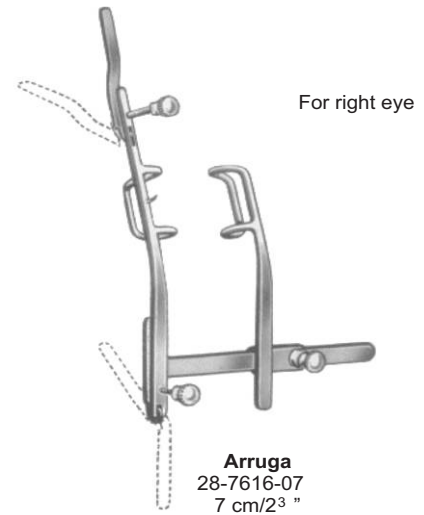
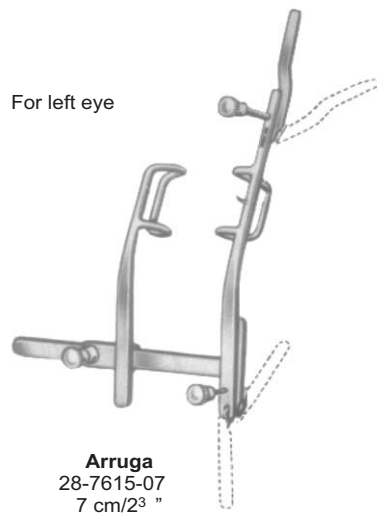
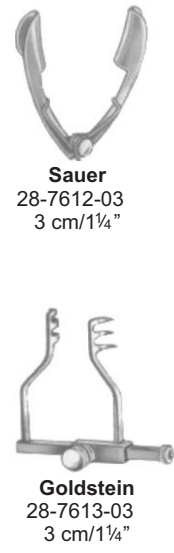
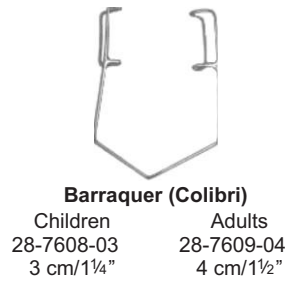
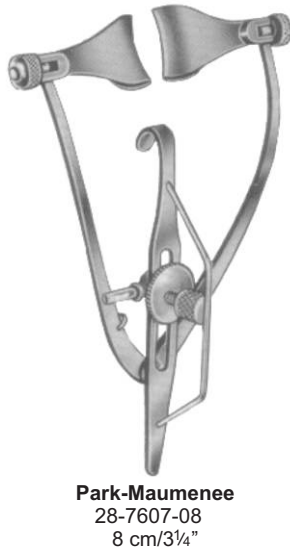
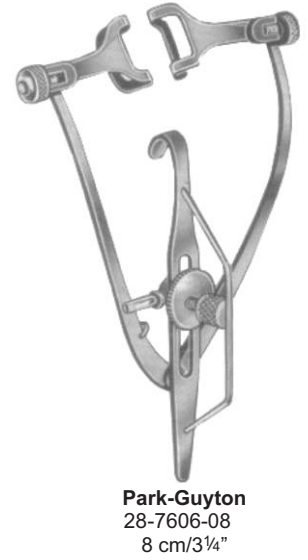
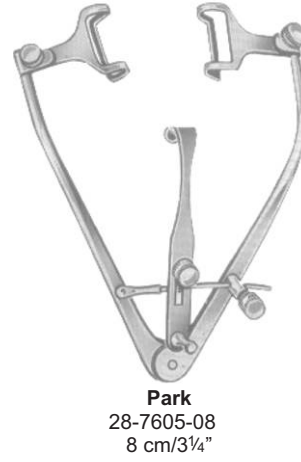

Eye Speculas ● EN
 Lidsperrer ● DE
 Espéculos ojo ● ES
 Spécules oculaires ● FR
 Eye Speculas ● IT



Mellinger-Axenfeld
 28-7617-07
 7 cm/2 3/4"



Mellinger-Axenfeld
 28-7618-07
 7 cm/2 3/4"



Children **Mellinger** Adults
 28-7619-05 28-7620-07
 5 cm/2 3/4" 7 cm/2 3/4"



Children **Mellinger Beard** Adults
 28-7621-05 28-7622-07
 5 cm/2" 7 cm/2 3/4"



Knapp Clark
 28-7623-08
 8 cm/3 1/4"



Children **Graefe** Adults
 28-7624-06 28-7625-09
 6 cm/2 1/2" 9 cm/3 1/2"



Lancaster
 28-7626-08
 8 cm/3 1/4"



Children **Williams** Adults
 28-7627-07 28-7628-08
 7 cm/2 3/4" 8 cm/3 1/4"



Lister-Burch
 28-7629-08
 8 cm/3 1/4"



Weiss
 28-7630-08
 8 cm/3 1/4"



Murdock
 28-7631-05
 5 cm/2"



Mueller
 28-7632-07
 7 cm/2 3/4"



Critchett
 28-7633-06
 6 cm/2 1/2"



Castroviejo
 28-7634-08
 8 cm/3 1/4"





Schepens
28-7635-13
13 cm/5"



Dearres
28-7636-13
13 cm/5"



Conway
28-7637-13
13 cm/5"

8 mm



Dearres
13 cm/5"



28-7638-12
12 mm



28-7638-14
14 mm



28-7638-16
16 mm



28-7638-18
18 mm

Lid plate



Jaeger
28-7639-11
11 cm/4 1/2"

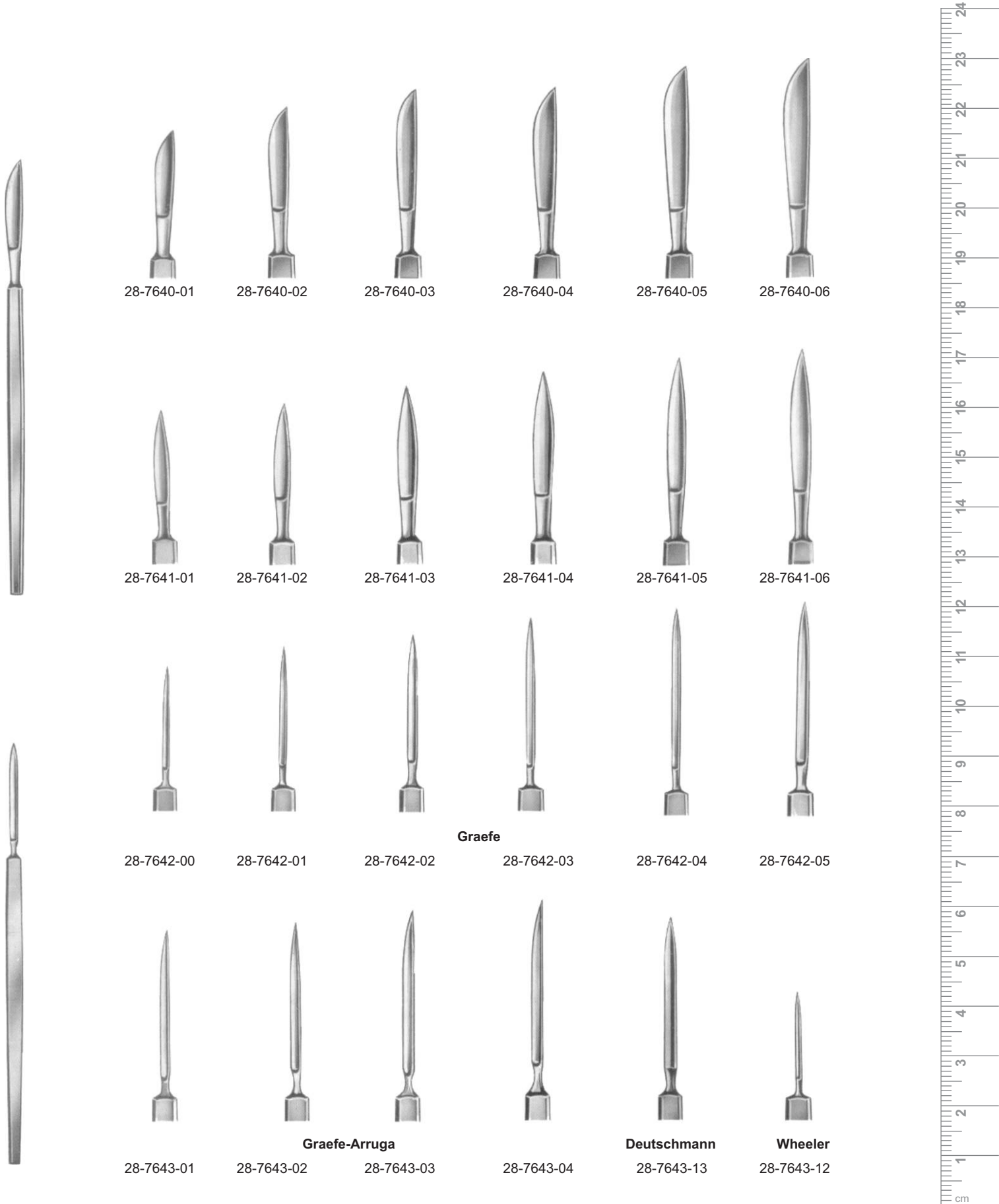

28-7640-01

28-7640-02

28-7640-03

28-7640-04

28-7640-05

28-7640-06

28-7641-01

28-7641-02

28-7641-03

28-7641-04

28-7641-05

28-7641-06

28-7642-00

28-7642-01

28-7642-02

Graefe

28-7642-03

28-7642-04

28-7642-05

28-7643-01

28-7643-02

Graefe-Arruga

28-7643-03

28-7643-04

Deutschmann

28-7643-13

Wheeler

28-7643-12



Jaeger
28-7644-01



28-7644-02



28-7644-03



28-7644-04



28-7645-01



28-7645-02



28-7645-03



28-7645-04



28-7646-01



28-7646-02



28-7646-03



28-7646-04



28-7647-01



28-7647-02



28-7647-03



28-7647-04

Jaeger-Grieshaber



28-7648-01



28-7648-02



28-7648-03

Jaeger-Grieshaber



28-7648-04

Keratomes, Various Eye Knives
 Keratomes, Verschiedene Eye Messer
 Keratomes, varios cuchillos de ojos
 Kératomes, divers couteaux oculaires
 Cheratomi, coltelli vari

- EN
- DE
- ES
- FR
- IT

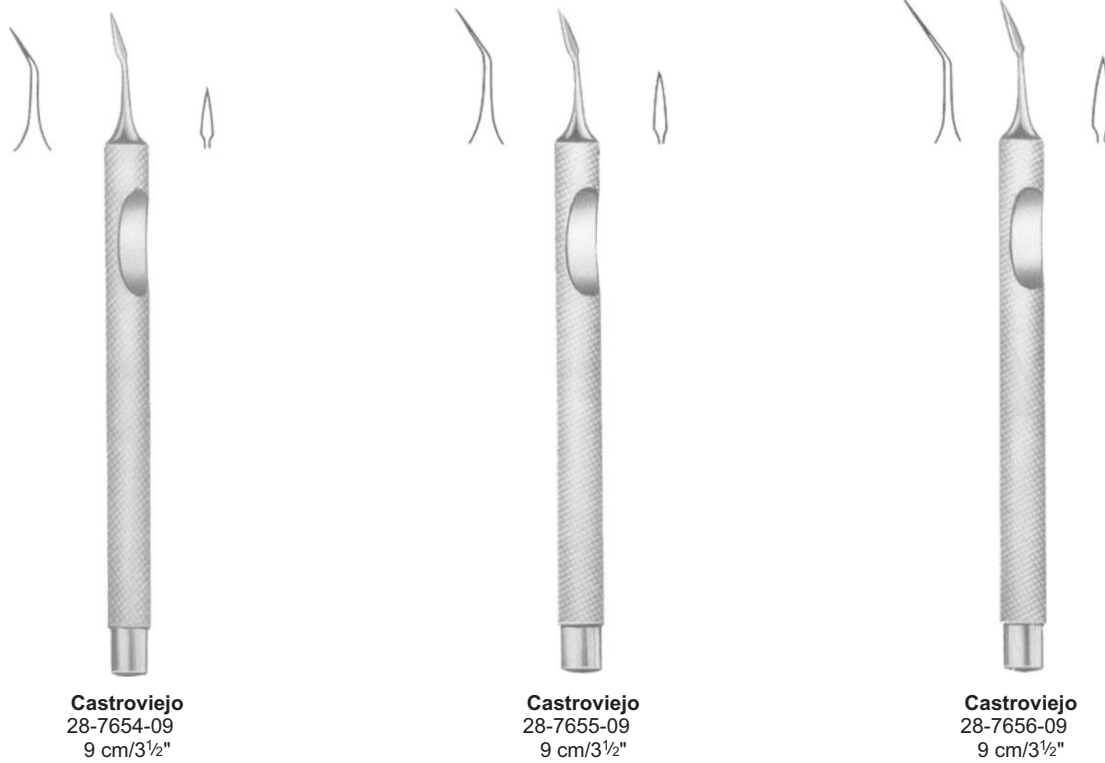



Mod. Hamburg
28-7657-12



Graefe
28-7658-13



28-7659-01



Weber
28-7659-02



28-7659-03



Bowman
28-7660-04
0.4 mm



Bowman
28-7660-05
0.5 mm



Bowman
28-7660-06
0.6 mm



Bowman
28-7660-07
0.7 mm



Bowman
28-7660-08
0.8 mm



Left **Bowman** Right
28-7661-01 28-7661-02



28-7662-01



Knapp
28-7662-02



28-7662-03



28-7663-05
5 mm



Ziegler
28-7663-06
6 mm



28-7663-07
7 mm

Various Eye Knives
 Verschiedene Eye Messer
 Varios cuchillos de ojos
 Divers couteaux oculaires
 Vari coltelli per occhi

- EN
- DE
- ES
- FR
- IT





Guthrie
28-7681-12



Guthrie
28-7682-13



Berens
28-7683-12



**Knapp
Blunt**
28-7684-13



**Rollet
Sharp**
28-7685-12



Rollet
28-7686-12



**Fink
Blunt**
28-7687-12



10.5 cm/4 1/4"

Right
28-7688-01

Left
28-7688-02



Knapp-Rollet
28-7689-02



Flexible
28-7689-03



28-7689-04



Axenfeld

Sharp
 28-7690-14

Blunt
 28-7691-14



Axenfeld

Sharp
 28-7692-14

Blunt
 28-7693-14



Paul
 28-7694-12



Sautter
 28-7695-01



Sautter
 28-7696-02



Sautter
 28-7697-03



Arruga
 28-7698-13



Stevens
 28-7699-14



Stevens
 28-7700-12



Graefe
 28-7701-01



Graefe
 28-7702-02



Graefe
 28-7703-03



Wecker
 28-7704-13



Wecker
 28-7705-13



Stock
 28-7706-13



Stock
 28-7707-13



Culler
 28-7708-13



Suker
 28-7709-14





Enucleation Scoops

all
28-7710-16

Large
28-7710-20

Wells

Chalazion Curettes

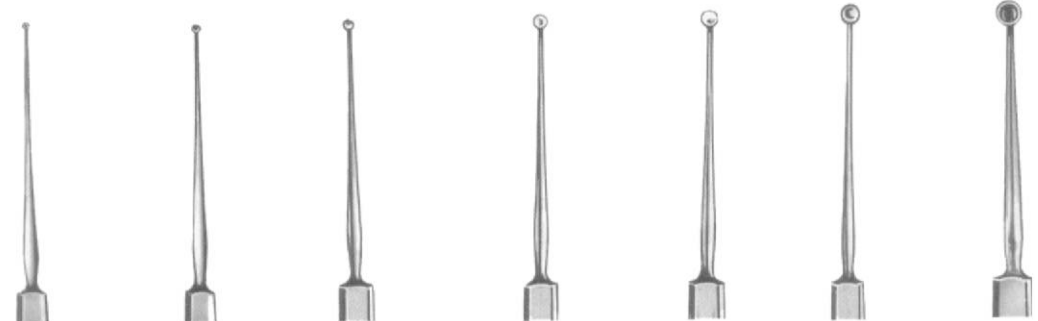

Meyhoefer

28-7711-05
0.5 mm Ø

28-7711-10
1.0 mm Ø

28-7711-15
1.5 mm Ø

28-7711-18
1.8 mm Ø

28-7711-20
2.0 mm Ø

28-7711-25
2.5 mm Ø

28-7711-35
3.5 mm Ø

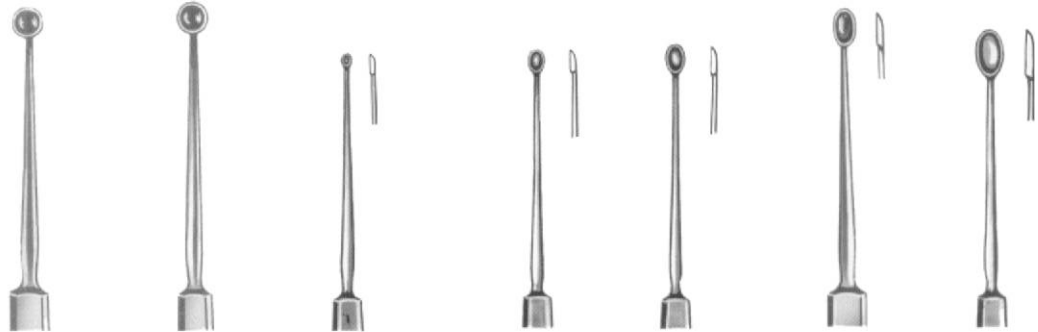

Hebra

Meyhoefer
28-7711-40
4.0 mm Ø

Meyhoefer
28-7711-45
4.5 mm Ø

28-7712-10
1.0 mm Ø

28-7712-20
2.0 mm Ø

28-7712-25
2.5 mm Ø

28-7712-30
3.0 mm Ø

28-7712-35
3.5 mm Ø

Exenteration Scoops



28-7713-01



28-7713-02



Bunge
 28-7713-03



28-7713-04



28-7713-05



Chalazion Curette, Double

Axenfeld
 28-7714-13
 13 cm/5"



Lachrymal Sac Dissector

Lang
 28-7715-13
 13 cm/5"



Irrigating Cannulas

Straight



nkhorst
28-7716-01
22 gauge

Right



nkhorst
28-7717-02
22 gauge

Left



nkhorst
28-7718-03
22 gauge

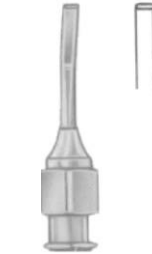

Bonn
28-7719-04
20 gauge



Bonn
28-7720-05
19 gauge

Probe Point



Hamburg
28-7721-06
23 gauge

Irrigation/Aspiration Cannulas



Simcoe
28-7722-01
23 gauge

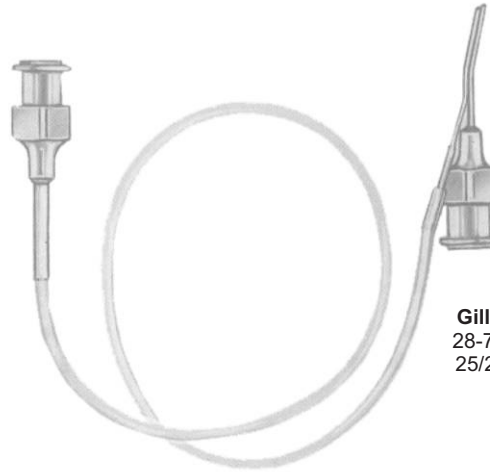

stotome Cannulas

Gills-Welsh
28-7723-02
25/23 gauge

Lens Manipulation Cannulas



Knolle-Kelmann
28-7724 -01
22 gauge



Nevyas
28-7725 -02
22 gauge



Kratz
28-7726 -03
22 gauge



Freeman
28-7727 -01
27 gauge

Irrigating Vectis Cannulas



Cortex Aspiration Cannulas



Capsule Polishing Cannulas





Castroviejo
28-7736-15



Castroviejo
28-7737-20
20 mm



Holth
28-7738-01



Haitz
28-7739-02



West
28-7740-16
16 cm/6 1/4"



West
28-7741-16
16 cm/6 1/4"

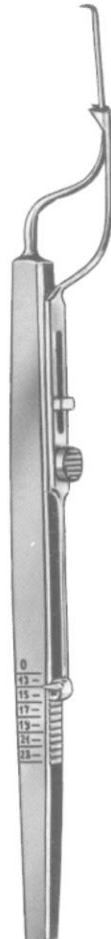

Connin-Amsler
28-7742-13
13 cm/5"



Wilder
28-7743-01



Wilder
28-7744-02



Wilder
28-7745-03

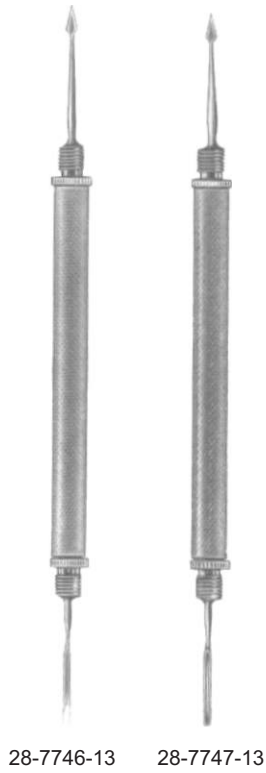

Needle Only
 28-7748-01

Chisel Only
 28-7748-02

Gouge Only
 28-7748-03



28-7749-13

Instrumentation for D. B. Kirby Operations



28-7750-10



Teeth
 28-7751-10 1:2 Teeth
 28-7752-10 2:3 Teeth

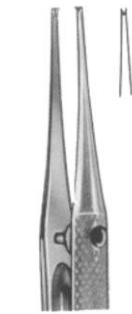

28-7753-10
 1 : 2



Kirby
 28-7754-10
 10 cm/4"



Kirby
 28-7755-10
 10 cm/4"



28-7756-10



28-7757-10





Tuengen
28-7758-10
10 cm/4"



28-7759-08
8.5 cm/3 1/2"



Paufique
28-7760-10
10 cm/4"



Barraquer
28-7761-10
10.5 cm/4 1/4"



McPherson
28-7762-10
10 cm/4"



McPherson
28-7763-07
7.5 cm/3"

OPHTHALMOLOGY



McCullough
 28-7764-09
 9.5 cm/3 3/4"



McCullough
 28-7765-09
 9.5 cm/3 3/4"



Bonaccoito
 28-7766-10
 10 cm/4"



Bonaccoito
 28-7767-10
 10 cm/4"



28-7768-11
 11 cm/4 1/2"



11 cm/4 1/2"



28-7769-11
 1 : 2



28-7770-11
 2 : 3



Nugent
 10 cm/4"



28-7771-01



28-7772-02



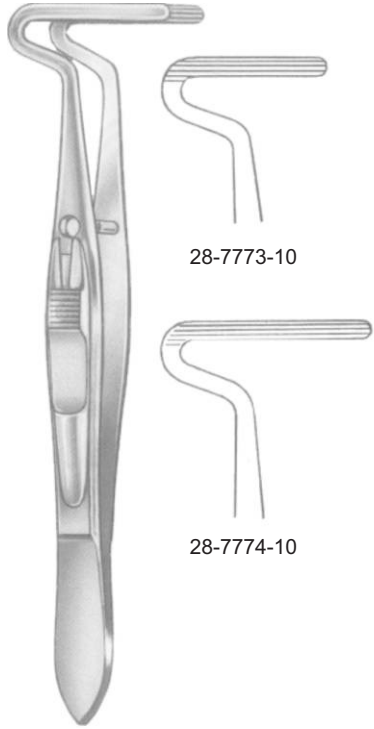

Berke
10 cm/4"



Blascovics
28-7775-09
9 cm/3 1/2"

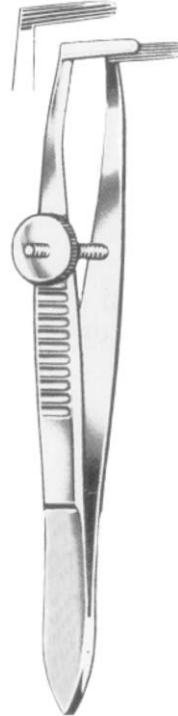

Blascovics
28-7776-09
9 cm/3 1/2"



Worth
28-7777-10
10 cm/4"

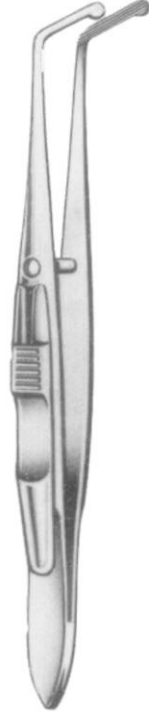

Worth
28-7778-10
10 cm/4"



Jameson
28-7779-10
10 cm/4"

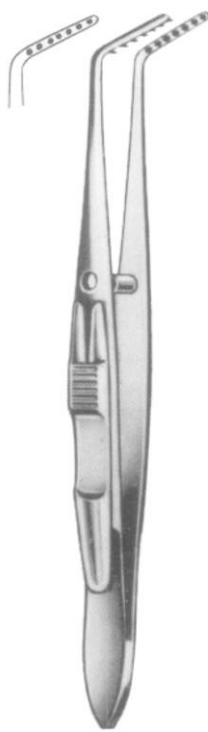

Jameson
28-7780-10
10 cm/4"



Prince
28-7781-10
10 cm/4"



Prince
28-7782-10
10 cm/4"

Entropium, Anterior Chamber Forceps ● EN
 Entropium, Vorderkammer Zange ● DE
 Entropion, pinzas Cámara Anterior ● ES
 Entropium, forceps de chambre antérieure ● FR
 Entropio, pinza della camera anteriore ● IT



Snellen
 28-7783-10
 10 cm/4"



Snellen
 28-7784-10
 10 cm/4"



Erhardt
 28-7785-09
 9 cm/3 1/2"

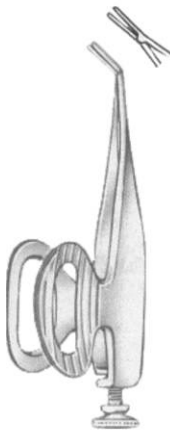

Barraquer
 28-7786-05
 5.5 cm/2 1/4"

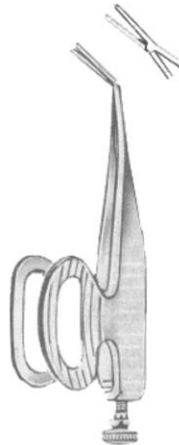

Barraquer
 28-7787-05
 5.5 cm/2 1/4"



Barraquer
 28-7788-05
 5.5 cm/2 1/4"



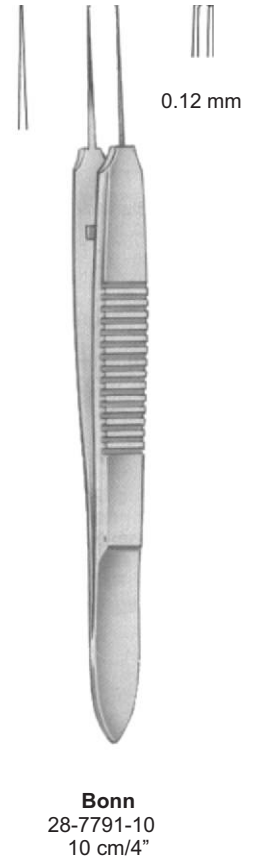
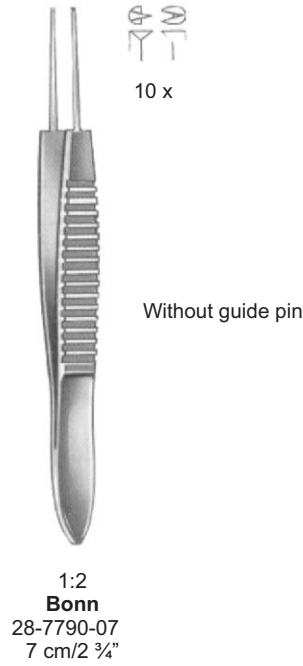



Graefe
 10 cm/4"



28-7796-10



28-7797-10



28-7798-10



28-7799-10



28-7800-10



28-7801-10

Conjunctival forceps



Stevens
 10.5 cm/4¼"



28-7802-10



28-7803-10



28-7804-10



28-7805-10



28-7806-10



28-7807-10



O'Connor
 28-7808-10
 10 cm/4"



Stevens
 28-7809-11
 11 cm/4½"



Stevens
 28-7810-11
 11 cm/4"



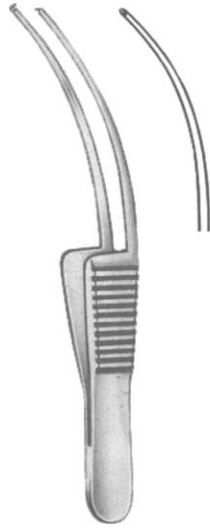

Fischer
28-7811-07
7 cm/2 3/4"

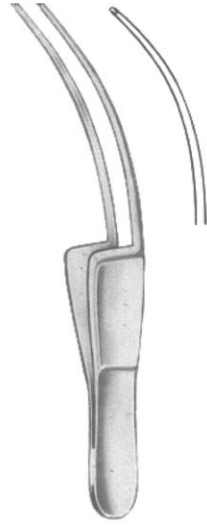

Fischer-Arit
28-7812-07
7 cm/2 3/4"



Hess
28-7813-07
7 cm/2 3/4"



Hess
28-7814-07
7 cm/2 3/4"



Serrated
28-7816-02



Fuchs
28-7817-07
7 cm/2 3/4"



Gill-Hess
28-7818-07
7.5 cm/3"



Gill-Hess
28-7819-07
7.5 cm/3"
Teeth on side

Teeth Below
28-7820-07

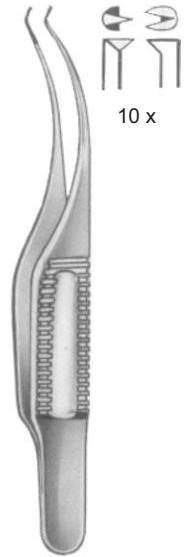

Barraquer-Katzin
(Colibri)
28-7821-07
7 cm/2 3/4"

Capsular Forceps — EN
 Kapsel-Pinzetten — DE
 capsular Pinzas — ES
 Pincès capsulaires — FR
 Pinza capsulare — IT



Fuchs
 28-7822-07
 7 cm/2 ¾"

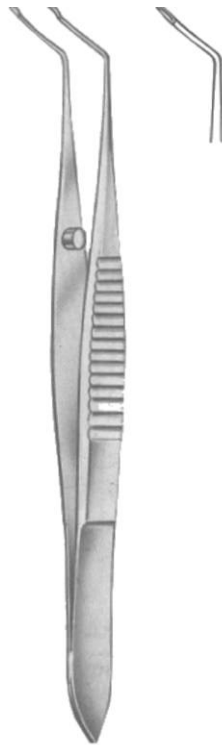

Kalt
 28-7823-10
 10 cm/4"



Terson
 28-7824-09
 9.5 cm/3 ¾"



Arruga-Nizetic
 28-7825-10
 10 cm/4"



Castroviejo
 28-7826-10
 10 cm/4"



Castroviejo
 28-7827-10
 10 cm/4"



Elschnig
 28-7828-10
 10 cm/4"

For Len Implantation



nkhorst
 28-7829-07
 7 cm/2 ¾"



Arruga
 28-7830-09
 9.5 cm/3 ¾"



Arruga
 28-7831-09
 9.5 cm/3 ¾"

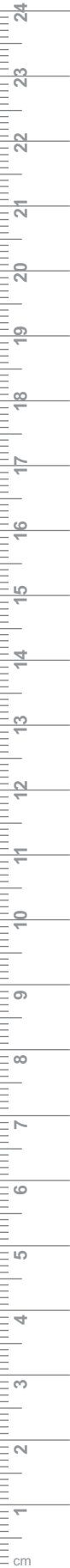



Knapp
28-7832-11
11 cm/4¼"



Ayer
28-7833-09
9 cm/3½"



Ayer
28-7834-09
9 cm/3½"



Lambert
28-7835-09
9 cm/3½"



Dearres
9 cm/3½"



28-7836-01



28-7837-02



28-7838-03



Fig. 1

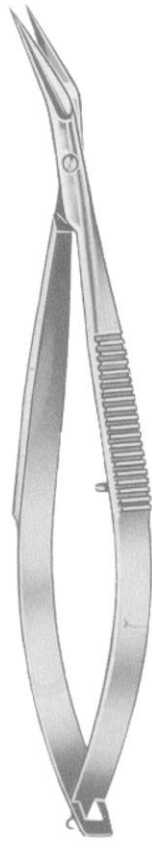

Fig. 2



Fig. 3

Noyes
 Fig.1 28-7839-01
 Fig.2 28-7839-02
 Fig.3 28-7839-03
 12 cm/4 3/4"



Noyes
 28-7840-12
 12 cm/4 3/4"



Wecker
 28-7842-02
 11.5 cm/4 1/2"



28-7841-01



28-7842-02



Barraquer
 28-7843-05
 5.5 cm/2 1/4"

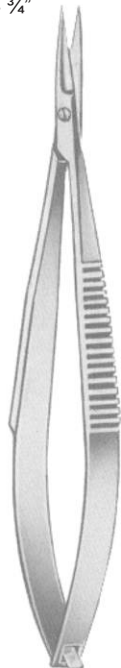

28-7844-09
 9 cm/3 1/2"



28-7845-09



28-7846-09



28-7847-09



28-7848-09



28-7849-09



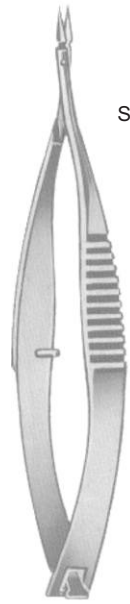

Straight

Vannas
28-7850-08
8 cm/3 1/4"

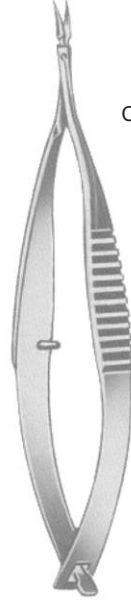

Curved

Vannas
28-7851-08
8 cm/3 1/4"

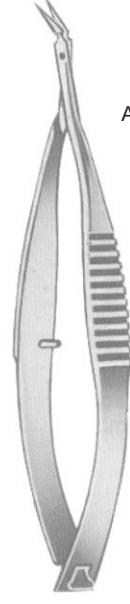

Angular

Vannas
28-7852-08
8 cm/3 1/4"

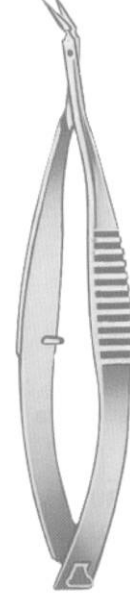

Vannas
28-7853-08
8 cm/3 1/4"



Straight

28-7854-08
8.5 cm/3 1/4"

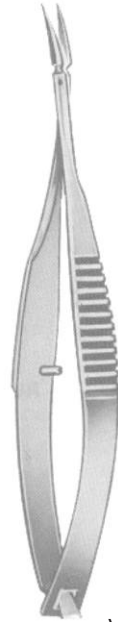

Curved

28-7855-08
8.5 cm/3 1/4"

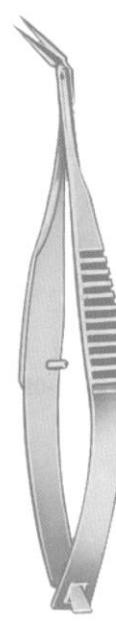

Angular

28-7856-08
8.5 cm/3 1/4"

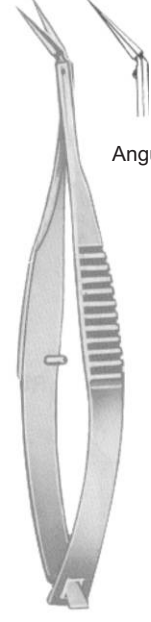

Angular

28-7857-08
8.5 cm/3 1/4"

Iridectomy Scissors ● EN
 Iridektomie Scissors ● DE
 Tijeras iridectomia ● ES
 Ciseaux d'iridectomie ● FR
 Forci per iridectomia ● IT

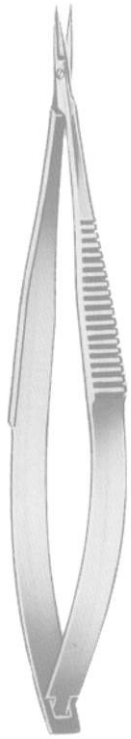

28-7858-10
 10 cm/4"



28-7859-10
 10 cm/4"



Castroviejo
 28-7860-10
 10 cm/4"



Castroviejo
 28-7861-10
 10 cm/4"



Aebli
 28-7862-10
 10 cm/4"

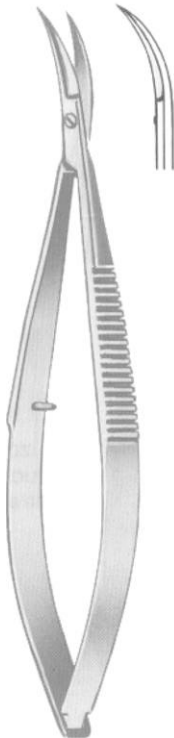

Castroviejo
 28-7863-10
 10 cm/4"

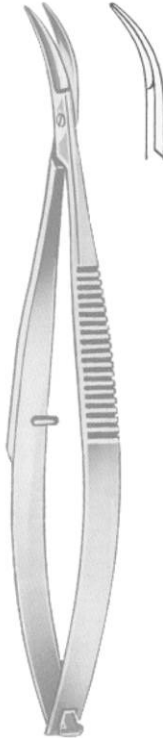

Castroviejo
 28-7864-10
 10 cm/4"

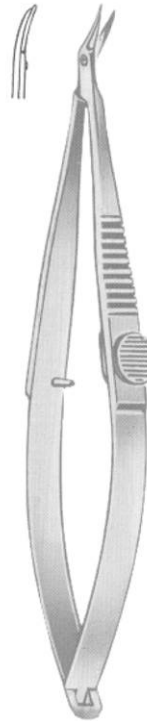

Troutman-Barraquer
 28-7865-10
 10 cm/4"

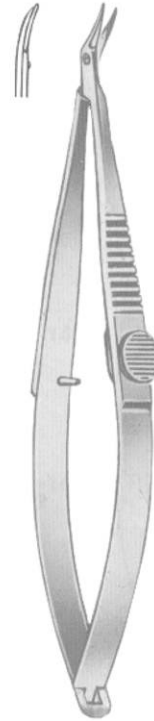

Troutman-Barraquer
 28-7866-10
 10 cm/4"



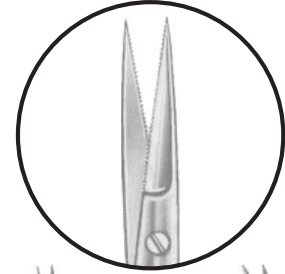

Saw Edge

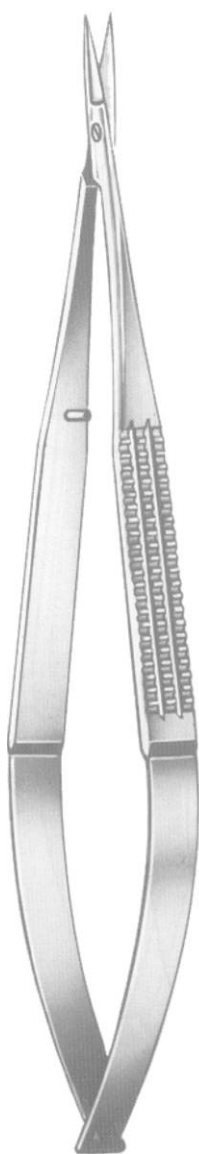

Straight
28-7867-16
16cm/6 1/4"

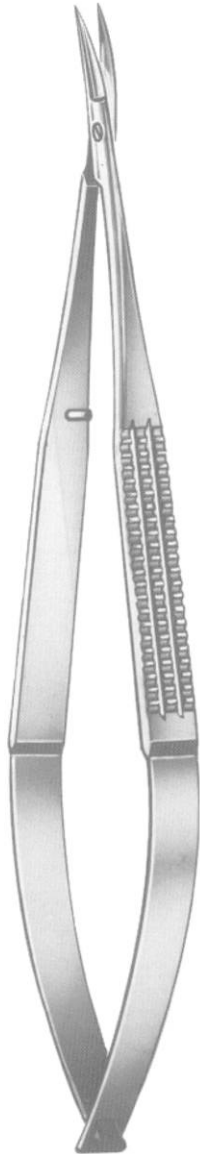

Curved
28-7868-16
16cm/6 1/4"

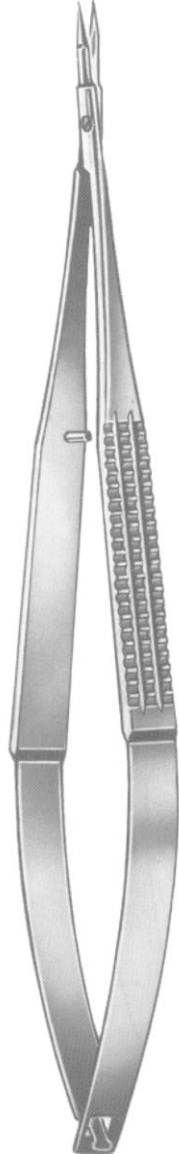

Straight
28-7869-16
16cm/6 1/4"

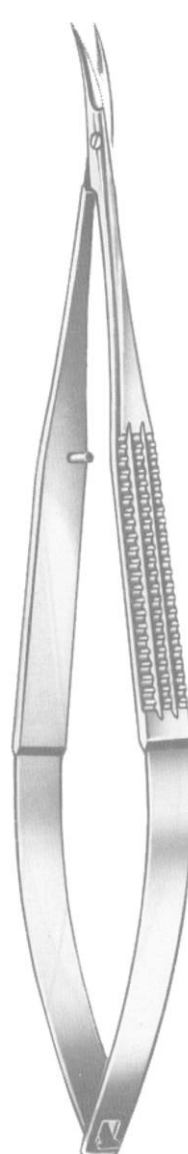

Curved
28-7870-16
16cm/6 1/4"

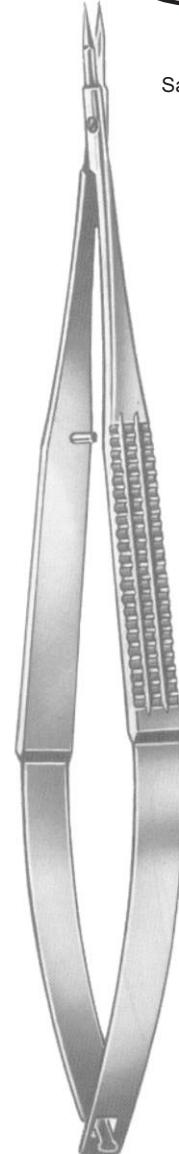

Millesi
Straight
28-7871-16
16cm/6 1/4"

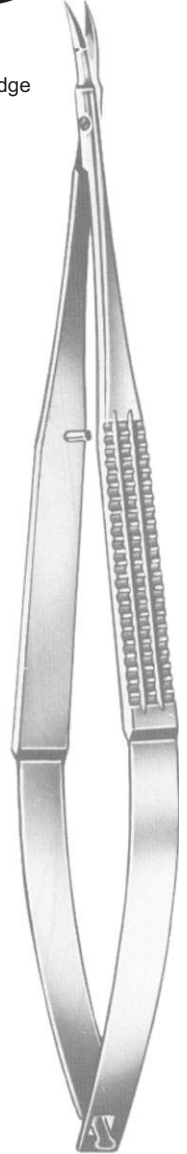

Millesi
Curved
28-7872-16
16cm/6 1/4"



Straight
 28-7873-18
 18.5cm/7 ¼"

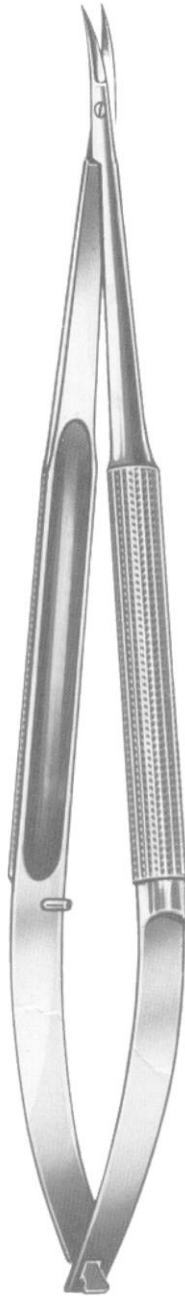

Curved
 28-7874-18
 18.5cm/7 ¼"

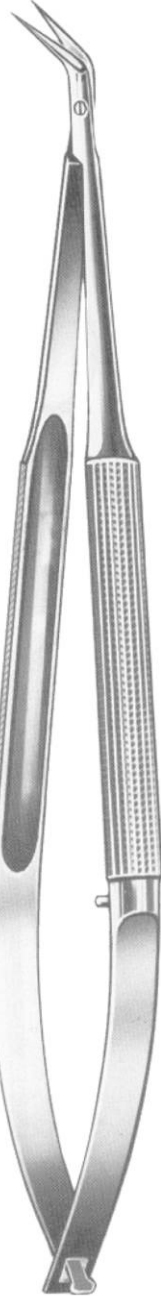

Angular
 28-7875-18
 18.5cm/7 ¼"



Straight
 28-7876-23
 23cm/9"



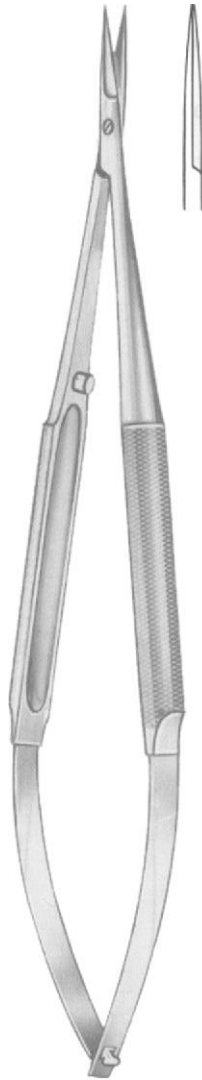

Straight
28-7877-14
14.5cm/5 3/4"



Curved
28-7878-14
14.5cm/5 3/4"

Dissecting Scissors



Curved
28-7879-14
14.5cm/5 3/4"