

EN	Rhinology
DE	Rhinologie
ES	Rinología
FR	Rhinologie
IT	Rinologia

Page 541 to 574

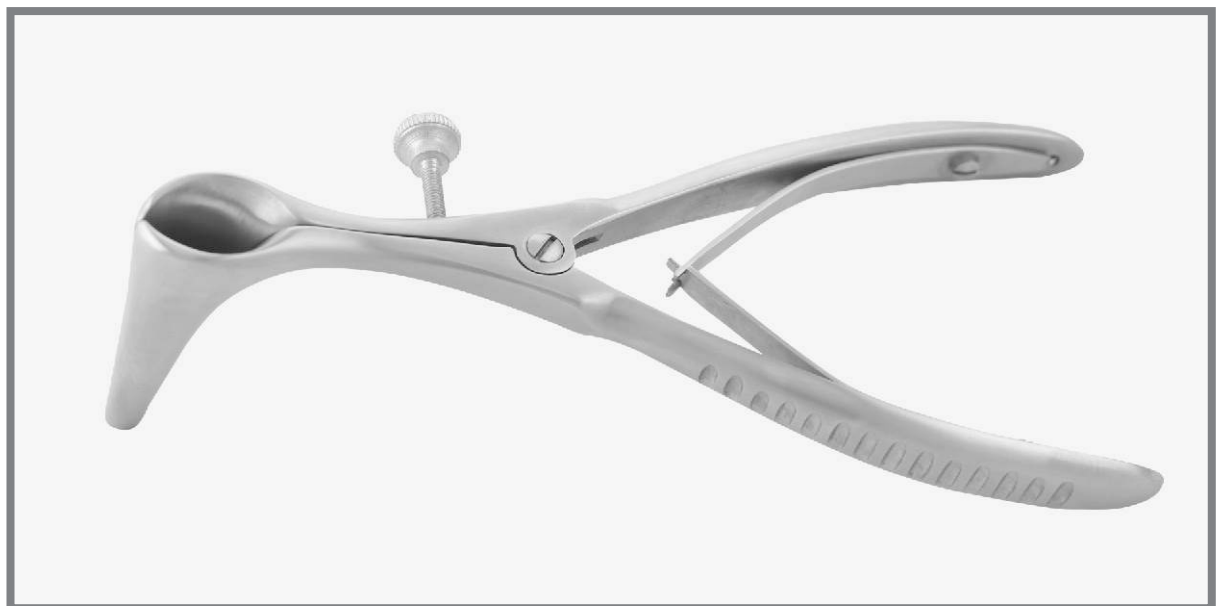

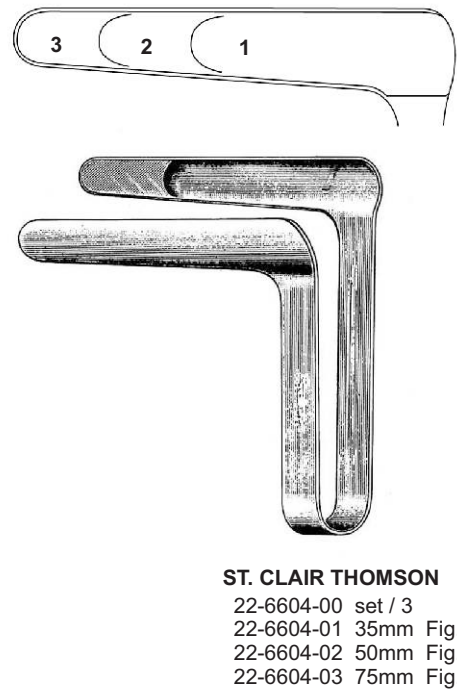

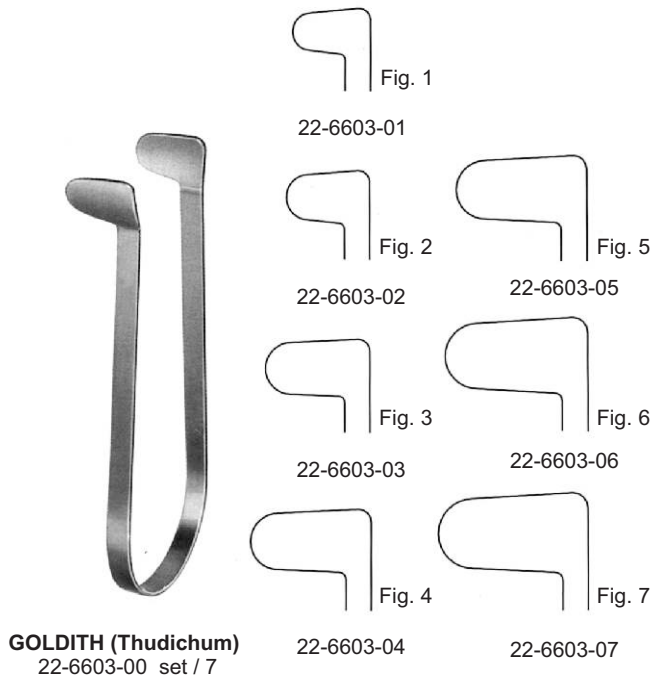
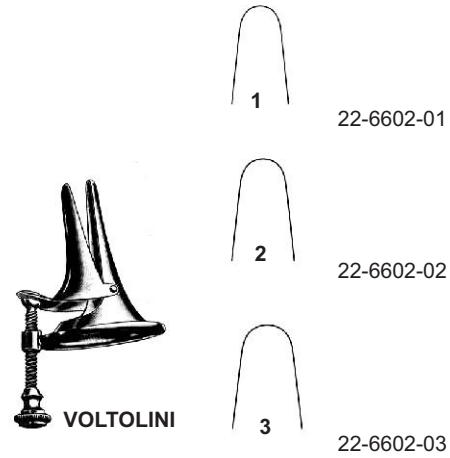
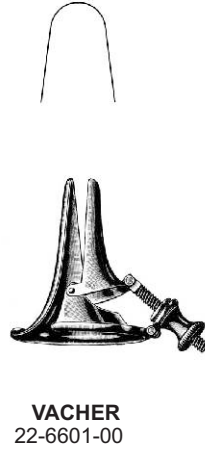

HARTMANN-HALLE
 15.0cm
 22-6605-01 Fig. 1
 22-6605-02 Fig. 2
 22-6605-03 Fig. 3

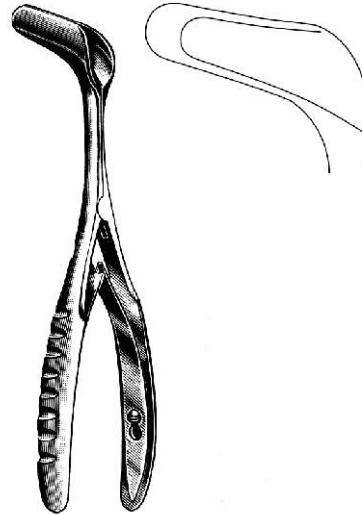
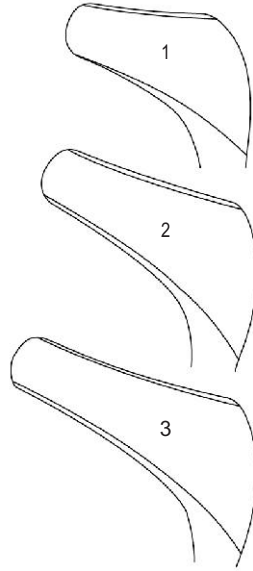

SCHWARZ
 22-6606-14
 14.0cm



VIENNA
 14.5cm
 22-6607-01 (infant)
 22-6607-02 (child)
 22-6607-03 (adult)
 22-6607-04 (sheet metal)

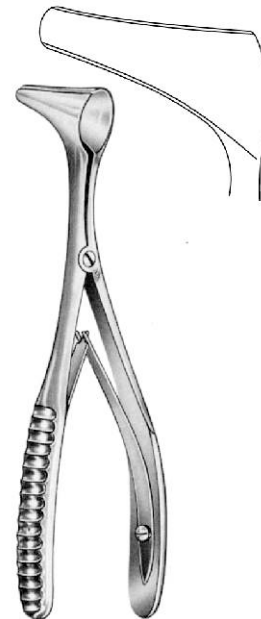

MOD WIEN
 22-6608-14
 14.5cm





22-6609-13
13.0cm



22-6610-13
13.0cm



TIECK-HALLE
13.5cm
22-6611-01
22-6611-02

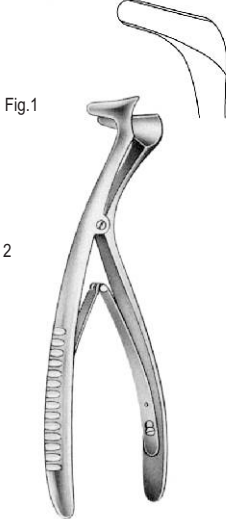

TIECK-HALLE
22-6612-13
13.5cm



KILLIAN
13.0cm
22-6613-35
22-6613-50
22-6613-75
22-6613-90

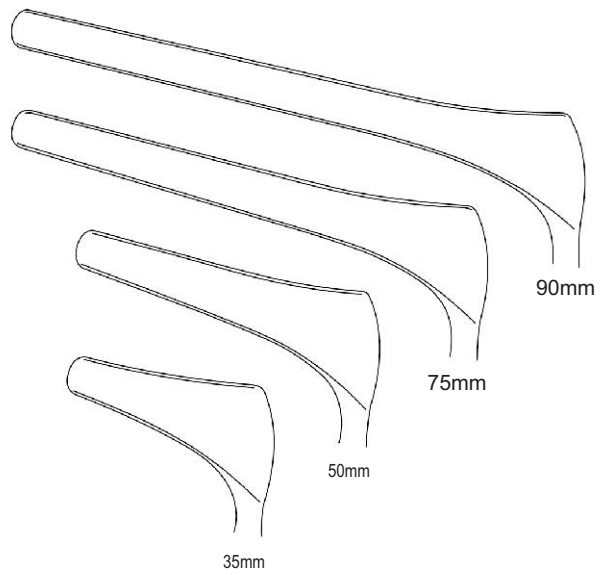

KILLIAN (with side screw)
13.0cm
22-6614-35
22-6614-50
22-6614-75
22-6614-90



COTTLE
 15.0cm
 22-6615-35
 22-6615-50
 22-6615-75
 22-6615-90

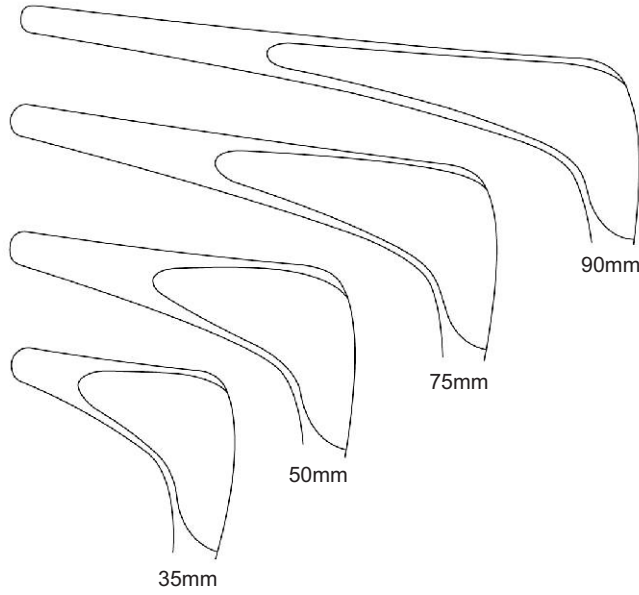

COTTLE (with side screw)
 15.0cm
 22-6616-35
 22-6616-50
 22-6616-75
 22-6616-90



COTTLE
 (dull black chromium plated)
 14.0cm

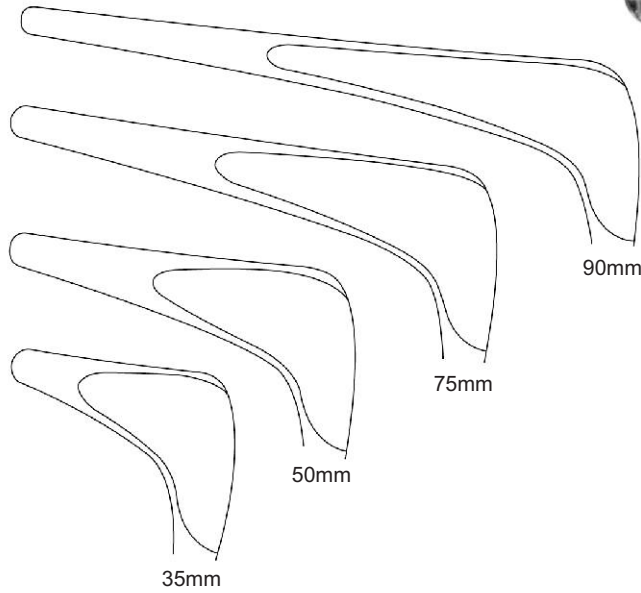

22-6617-35
 22-6617-50
 22-6617-75
 22-6617-90

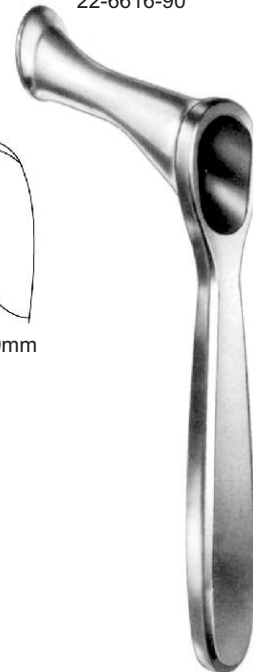

YANKAUER
 22-6618-19
 19.0cm



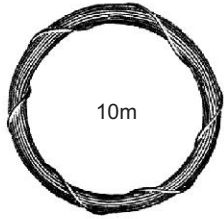

10m

22-6619-03 0.3mm Ø
22-6619-04 0.4mm Ø



22-6620-02 0.2mm Ø
22-6620-03 0.3mm Ø



KRAUSE
22-6621-26
26.0cm

KRAUSE-VOSS
22-6622-26
26.0cm

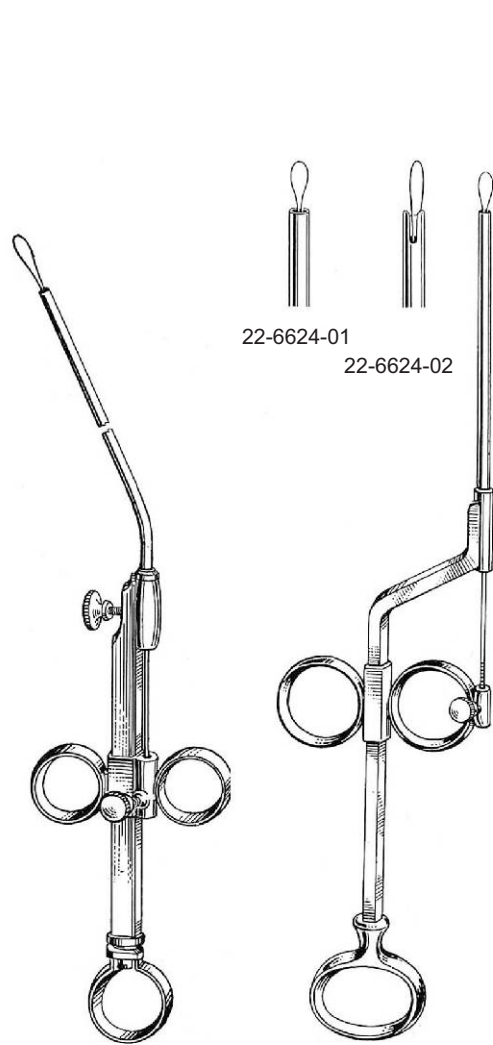

22-6624-01
22-6624-02

KRAUSE
22-6623-00

GLEGG

Nasal Polypus and Septum Compression Forceps
 Polypenzangen, Septumzange
 Pinzas para polipos, pinzas para el taque nasal
 Polypus nasal et pince à compression septum
 Pinza a compressione per polipo nasale e setto

- EN
- DE
- ES
- FR
- IT



KILLIAN
 22-6625-17
 17.0cm



LITTAUER
 22-6626-18
 18.0cm

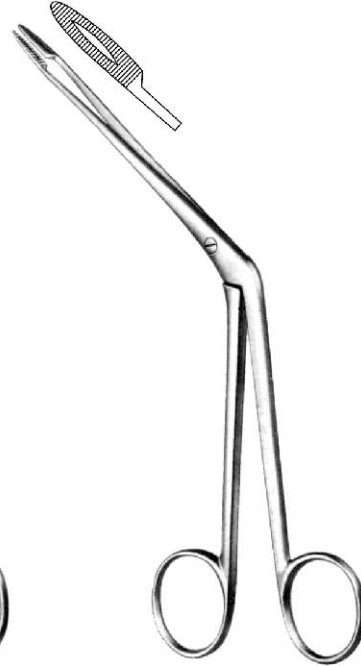

HARTMANN
 22-6627-20
 20.0cm



QUIRE
 22-6628-12
 12.0cm

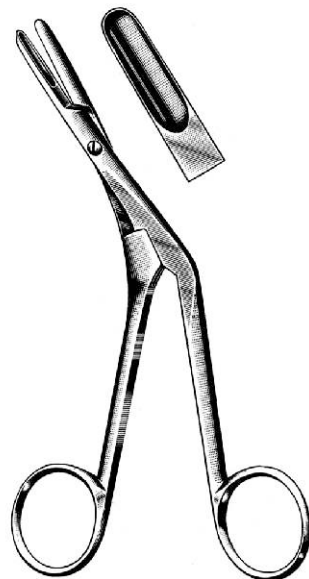

GRAIG
 22-6629-18
 18.0cm



22-6630-01 22-6630-02

18.0cm





KNIGHT
22-6631-18
18.0cm

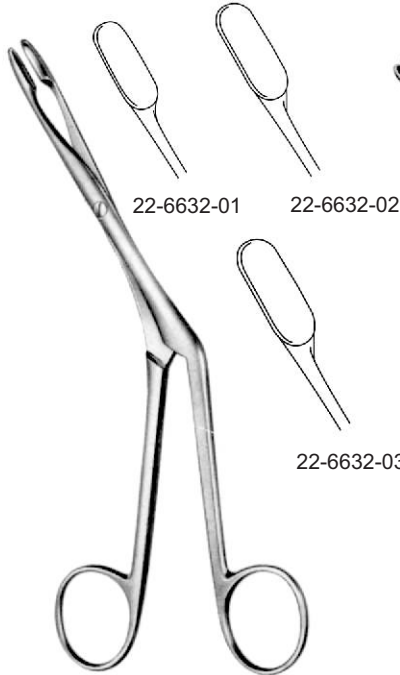

HEYMANN
18.0cm

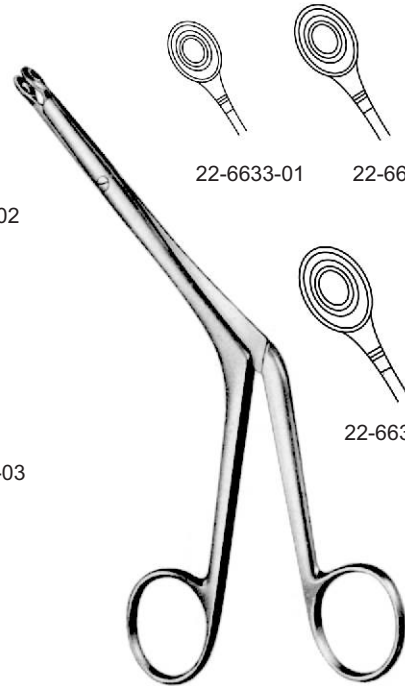

BRUENINGS
19.0cm

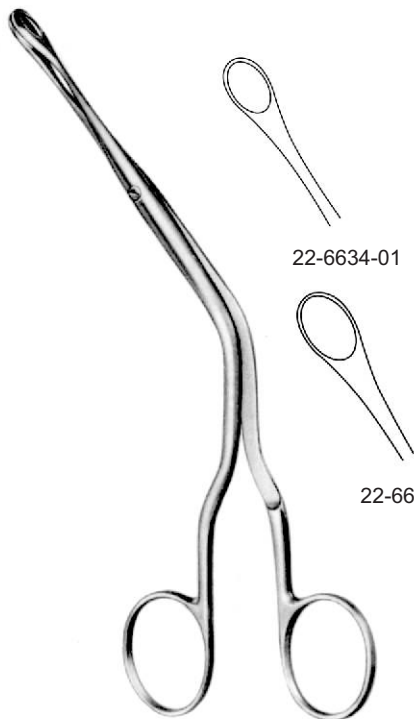

LUC
20.0cm

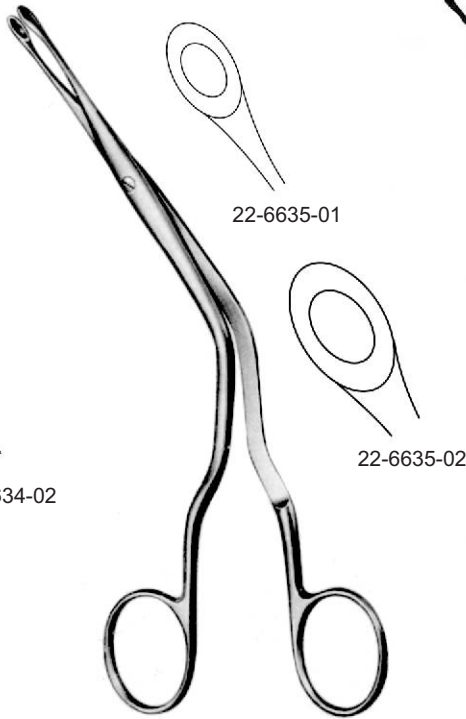

LUC
20.0cm

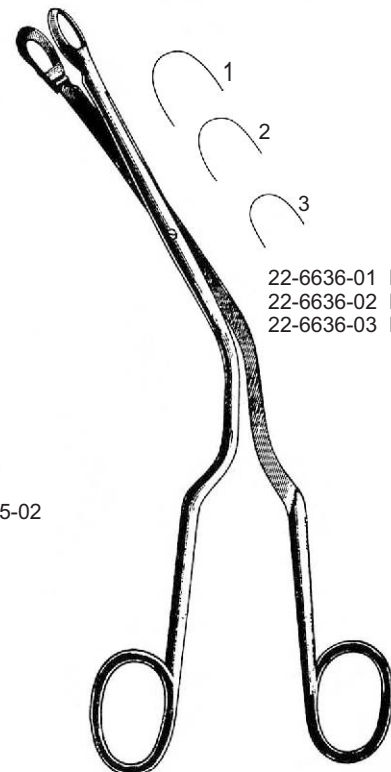

LUC
20.0cm

22-6633-01 Fig. 1
22-6633-02 Fig. 2
22-6633-03 Fig. 3

RHINOLOGY

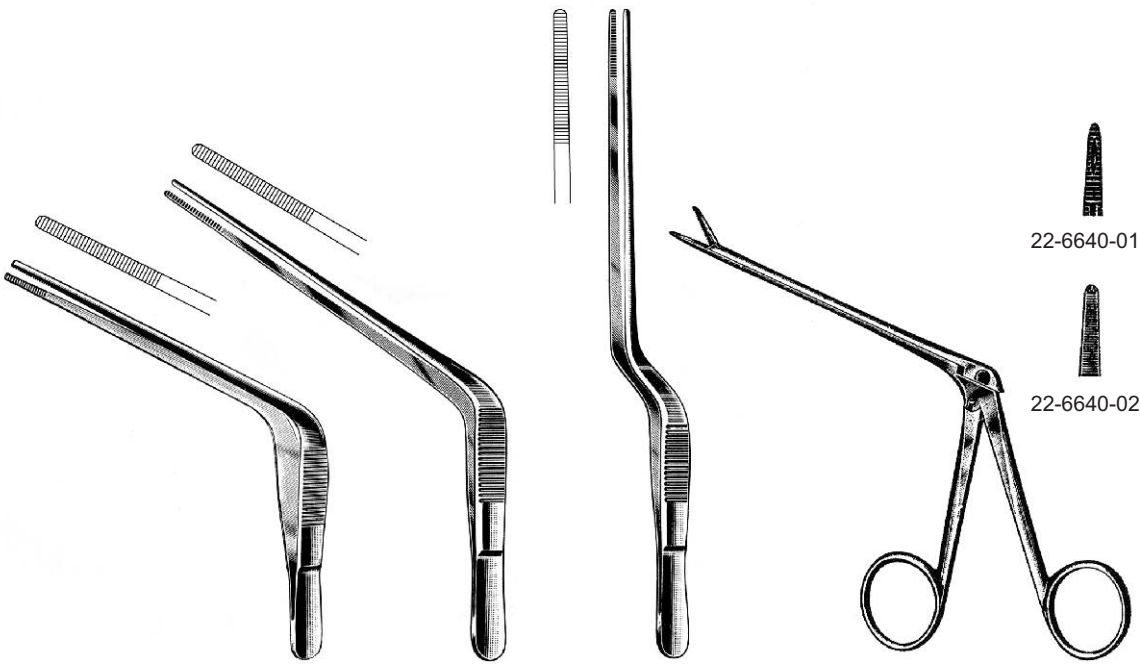

TROELTSCH
 22-6637-15
 15.0cm

TROELTSCH
 22-6638-18
 18.0cm

GRUENWALD (JANSEN)
 22-6639-20
 20.0cm

NOYES
 14.5cm

22-6640-01

22-6640-02



WESTMACOTT
 22-6641-20
 20.0cm

LUBET-BARBON
 22-6642-20
 20.0cm

HARTMANN
 22-6643-16
 16.0cm

HEYMANN-KNIGHT
 22-6644-18
 18.0cm



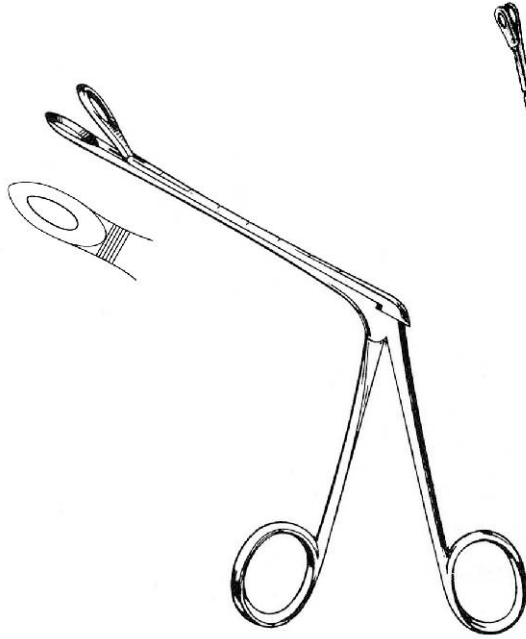

HENCKEL
22-6645-20
20.0cm

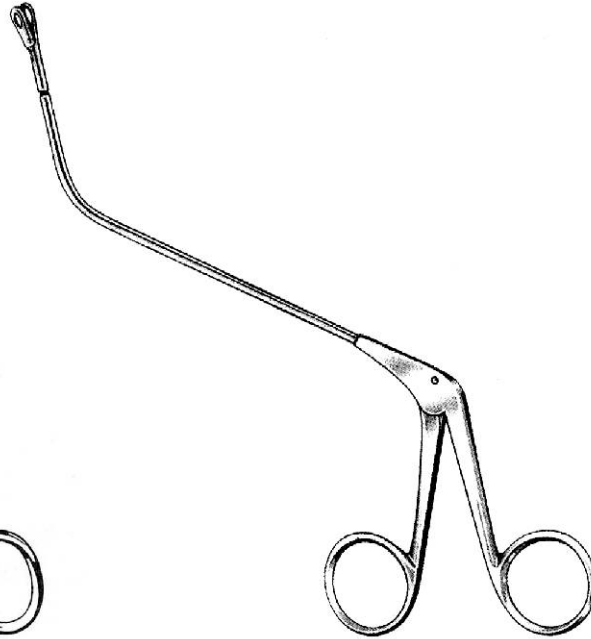

JATHO
22-6646-15

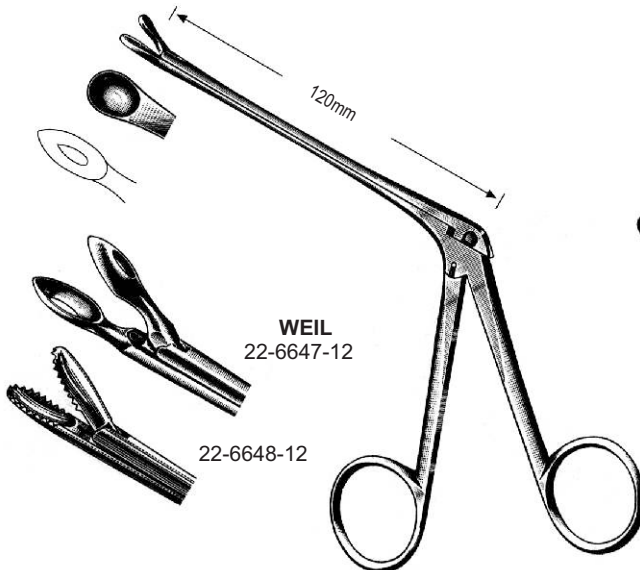

WATSON-WILLIAMS
22-6648-19
19.0cm

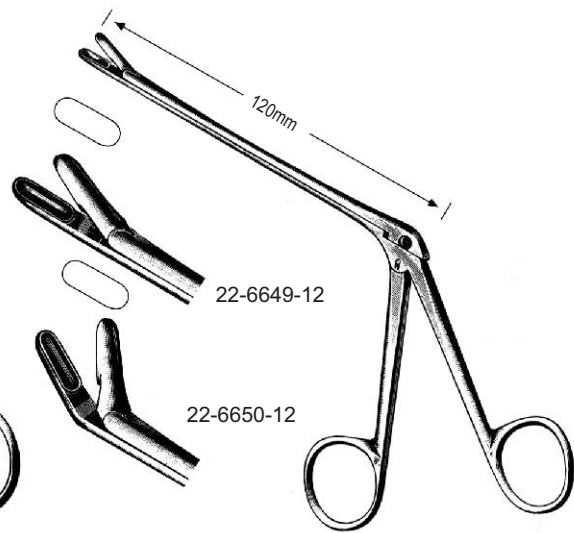

TAKAHASHI
19.0cm



WEIL
22-6647-12

22-6648-12

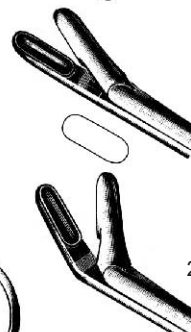

22-6649-12

22-6650-12



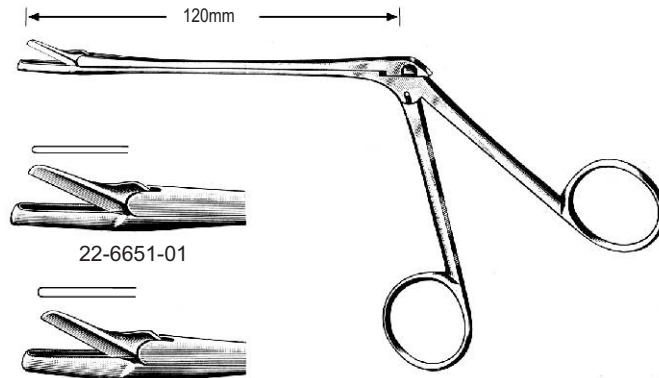

STRUYCKEN
 19.0cm

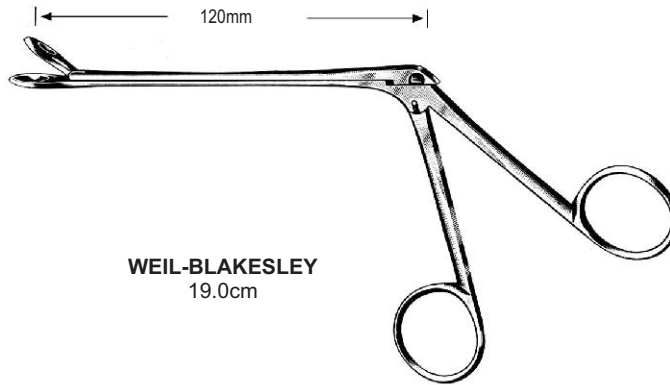

WEIL-BLAKESLEY
 19.0cm



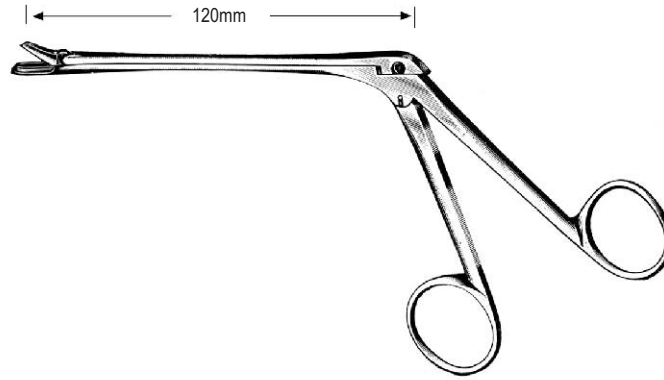

HAJEK
19.0cm



22-6654-12

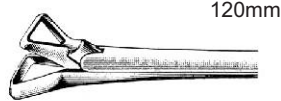

SCHMEDEN
19.0cm



22-6655-12

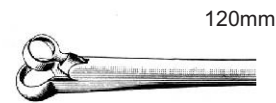

HARTMANN
19.0cm

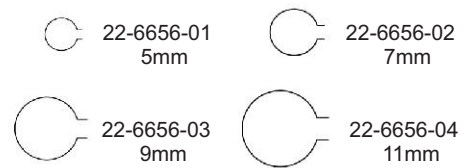

22-6656-01
5mm

22-6656-02
7mm

22-6656-03
9mm

22-6656-04
11mm

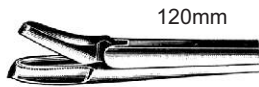

MYLES
19.0 cm

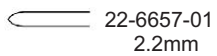

22-6657-01
2.2mm

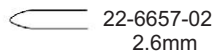

22-6657-02
2.6mm

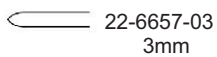

22-6657-03
3mm

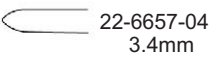

22-6657-04
3.4mm



22-6658-01

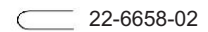

22-6658-02



22-6658-03

RHINOLOGY

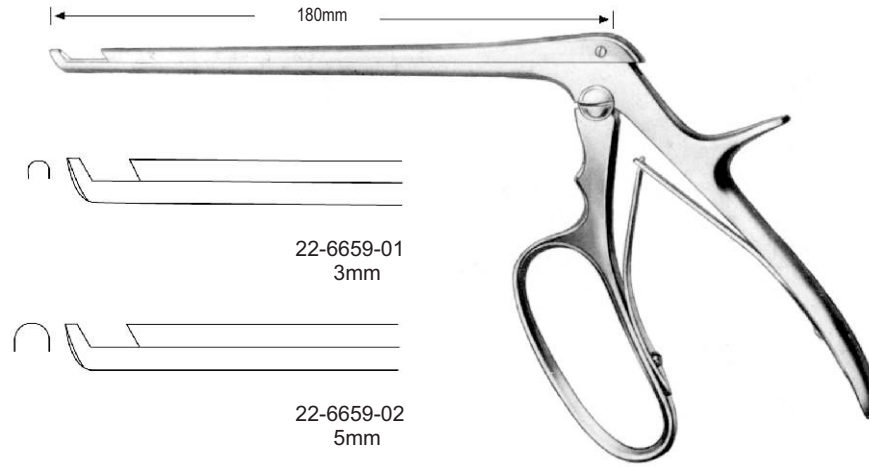

FERRIS-ITH-KERRISON
 (CLOWARD HARPER)

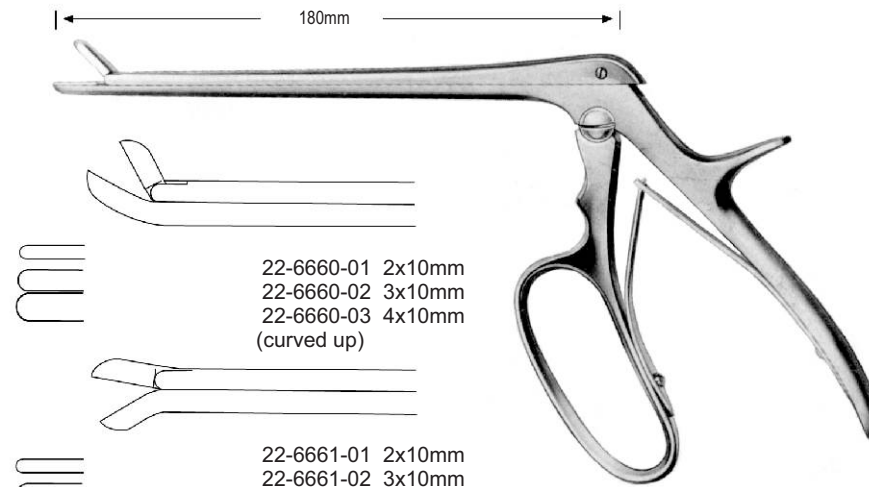

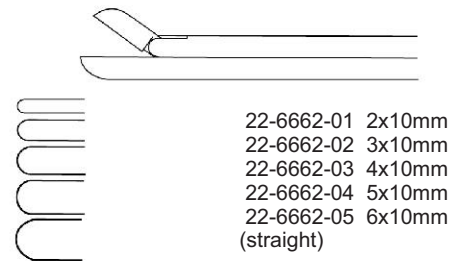

FERRIS-ITH-CUSHING

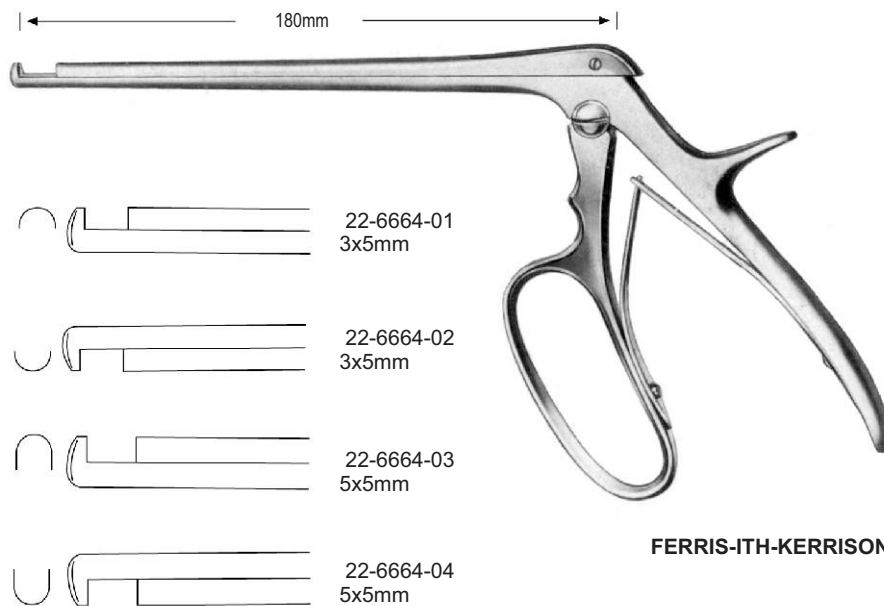
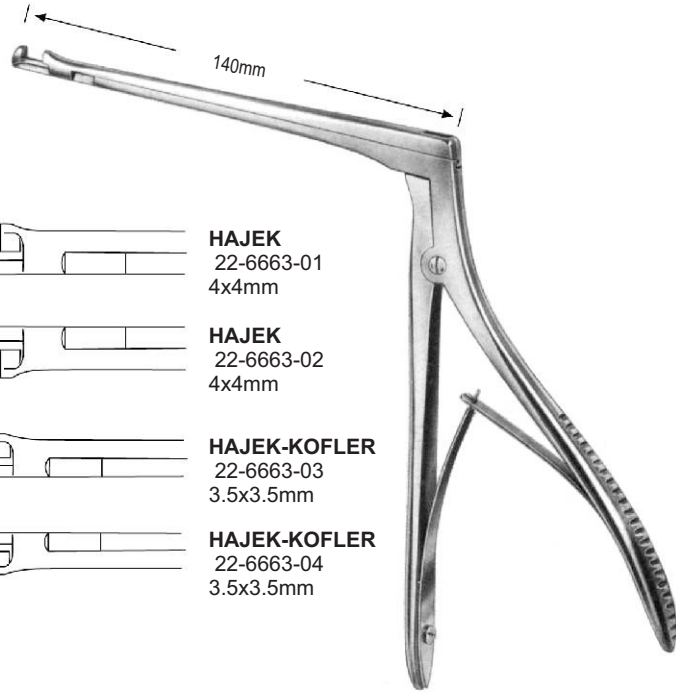



Sphenoid Punches and Rongeur Forceps
 Keibeinstanzen, Meißelzangen
 Pinzas cortantes para seno esfesoidal, pinzas-guas
 Poinçons sphénoïdes et forceps Rongeur
 Punzoni sfenoidali e pinze Rongeur

- EN
- DE
- ES
- FR
- IT

- 4x4mm  22-6665-01
4mm
- 5x5mm  22-6665-02
5mm
- 6x6mm  22-6665-03
6mm



KERRISON
20.0cm



HAJEK-CLAUS
22-6666-20
20.0cm



CITELLI
 22-6667-10 1mm
 22-6667-25 2.5mm
 22-6667-30 3mm
 22-6667-35 3.5mm
 22-6667-40 4mm



BEYER
22-6668-19
2mm



BEYER
22-6669-19
1mm

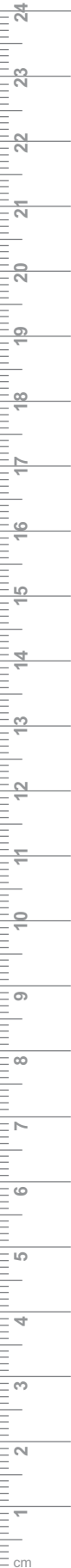

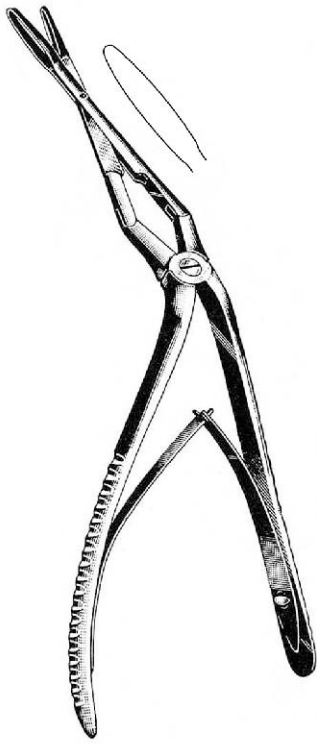

JANSEN-STRUYCKEN
22-6670-19
19.0cm



MIDDLETON-JANSEN
22-6671-19
19.0cm



MIDDLETON-JANSEN
22-6672-19
19.0cm



CAPLAN
22-6673-20
20.0cm

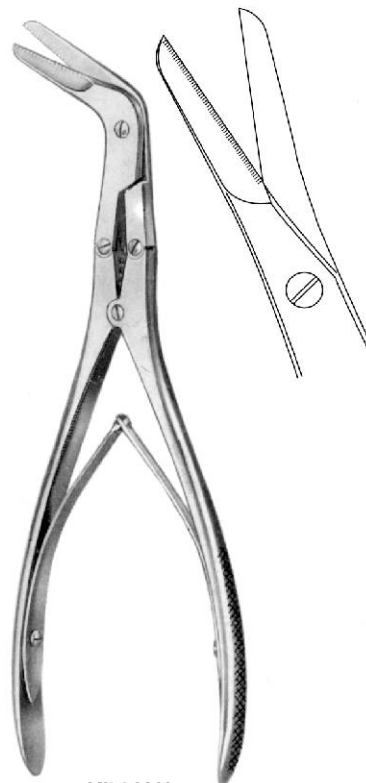

KILLIAN
22-6674-21
21.0cm



RUN
22-6675-21
21.0cm



RHINOLOGY

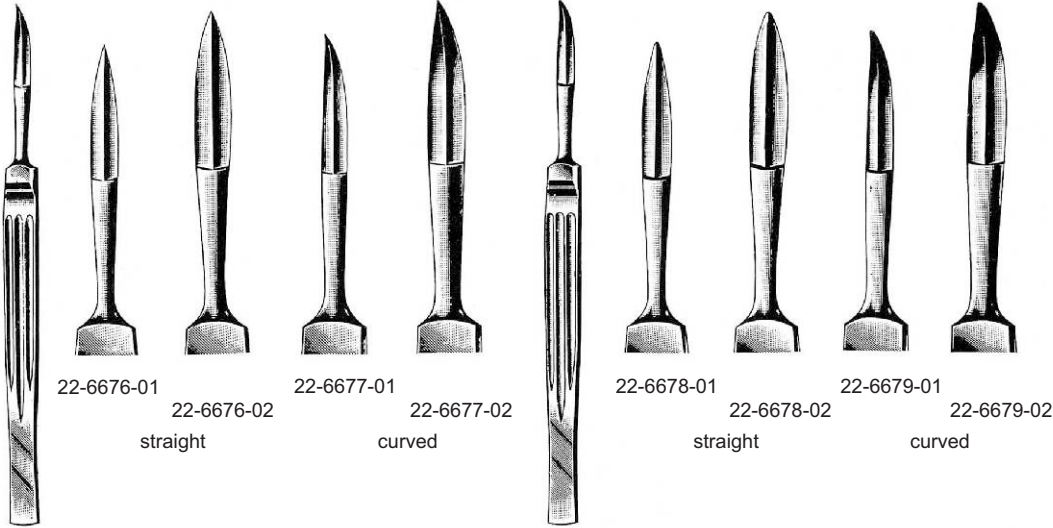

22-6676-01

22-6676-02

straight

22-6677-01

22-6677-02

curved

22-6678-01

22-6678-02

straight

22-6679-01

22-6679-02

curved

JOSEPH (sharp)
 15.0cm

JOSEPH (blunt)
 15.0cm

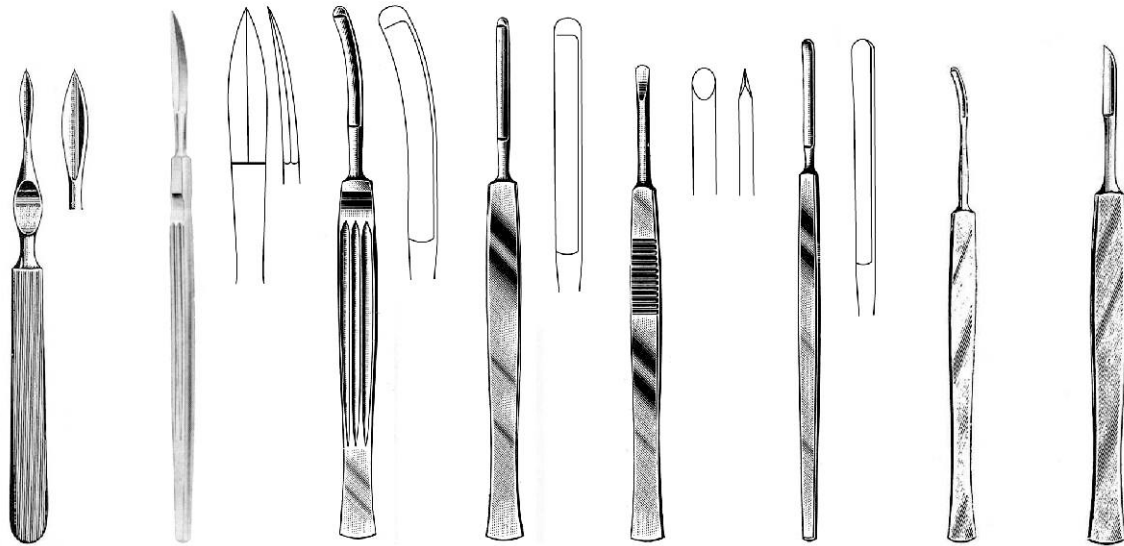

BALLINGER
 22-6680-00

FOMON
 22-6681-16
 16.0cm

CONVERSE
 22-6682-16
 16.0cm

JOSEPH
 22-6683-15
 15.0cm

COTTLE
 22-6684-15
 15.0cm

COTTLE
 22-6685-15
 15.0cm

HEYMANN
 22-6686-00

KRIEG
 22-6687-00





22-6688-03
3mm

BALLENGER
20.0cm



22-6688-04
4mm

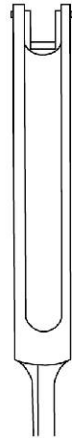

22-6688-05
5mm



22-6689-03
3mm

BALLENGER
20.0cm

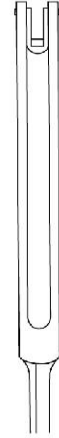

22-6689-04
4mm



22-6689-05
5mm



BRUENINGS
22-6690-16
16.5cm



FREER
22-6691-00



FREER
22-6692-15
15.0cm

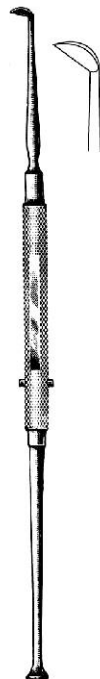

FREER
22-6693-19
19.0cm



FREER
22-6694-19
19.0cm

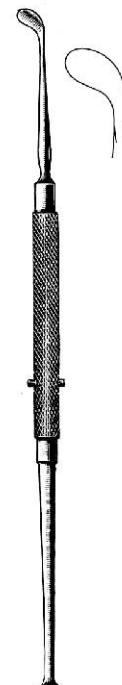

FREER
22-6695-19
19.0cm

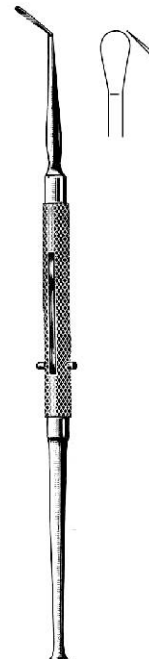

FREER
22-6696-19
19.0cm

RHINOLOGY

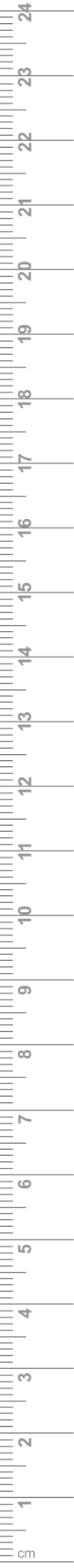
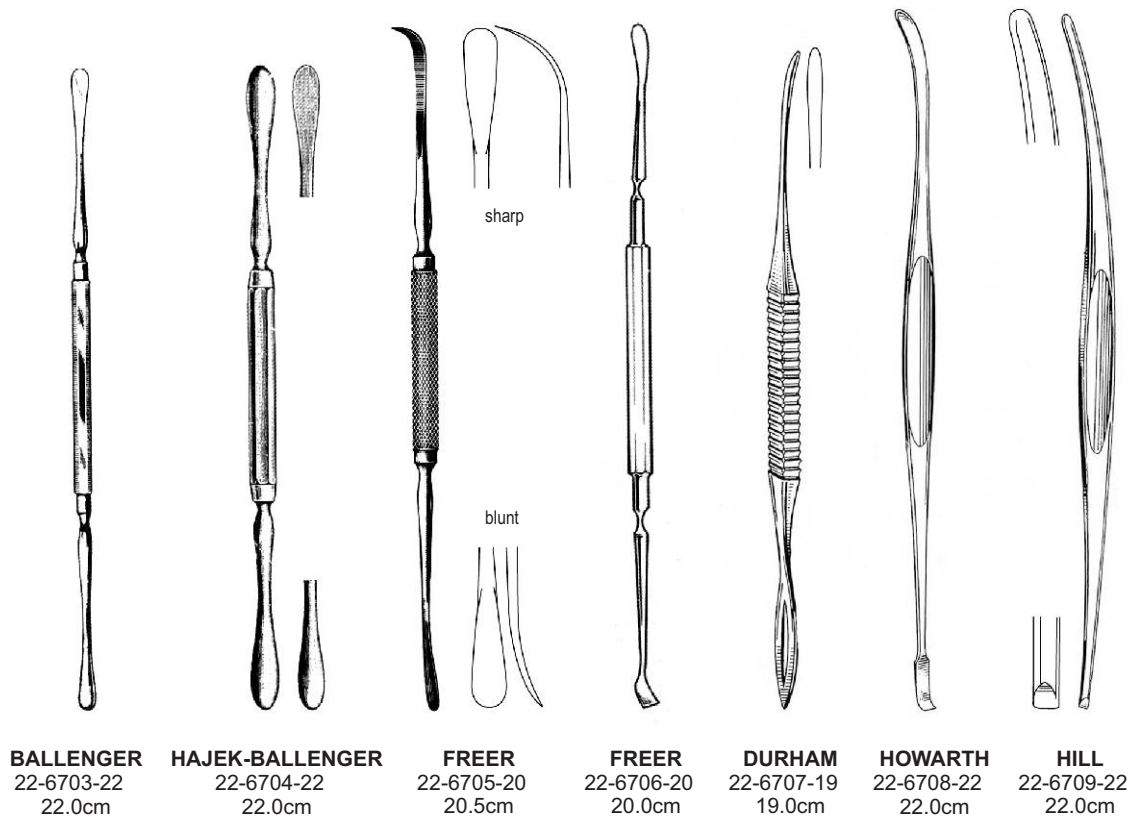
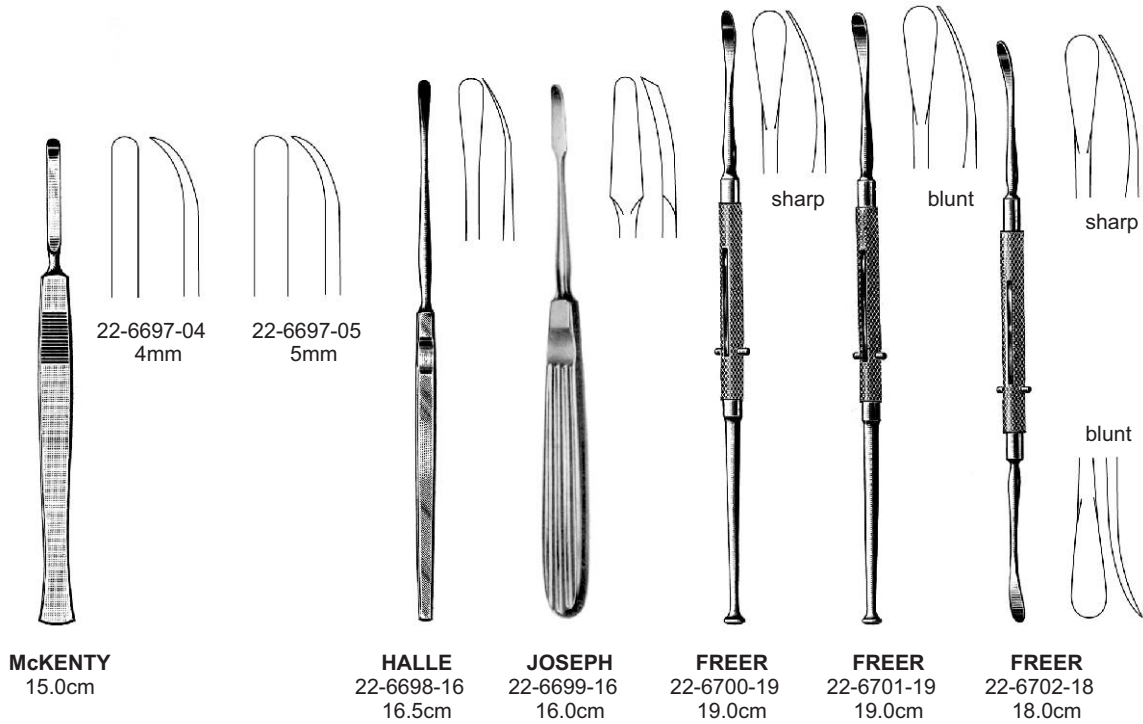

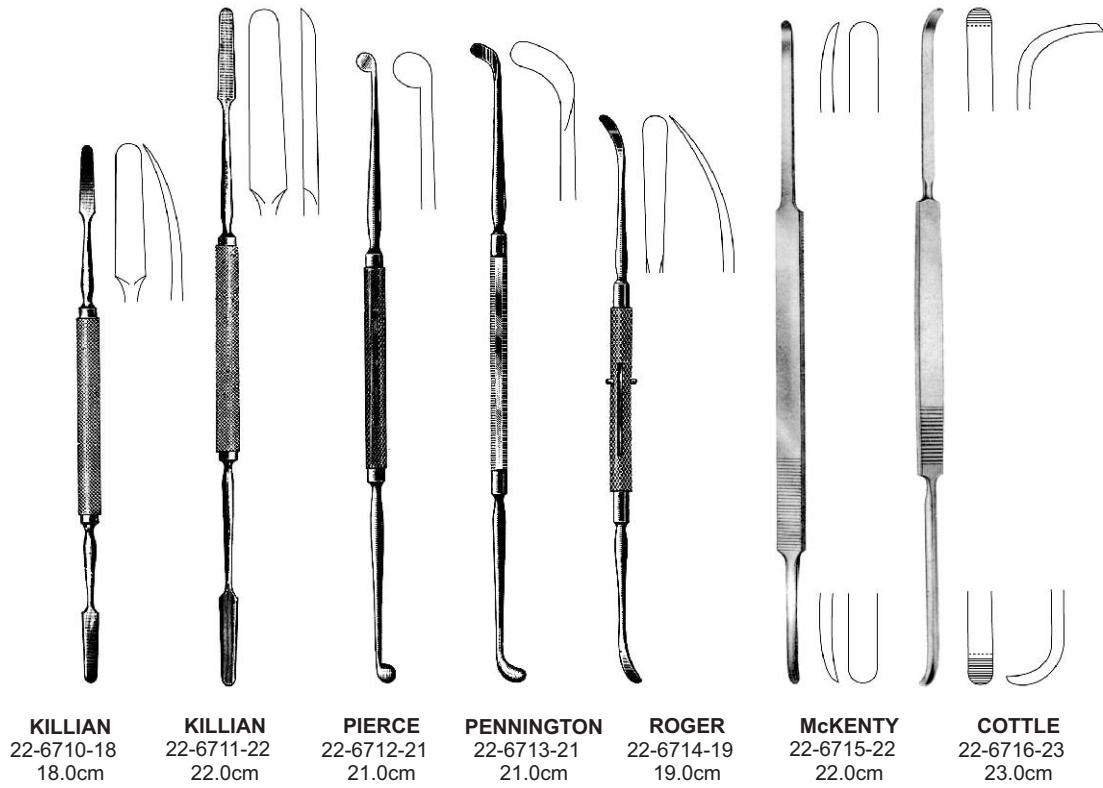

RHINOLOGY

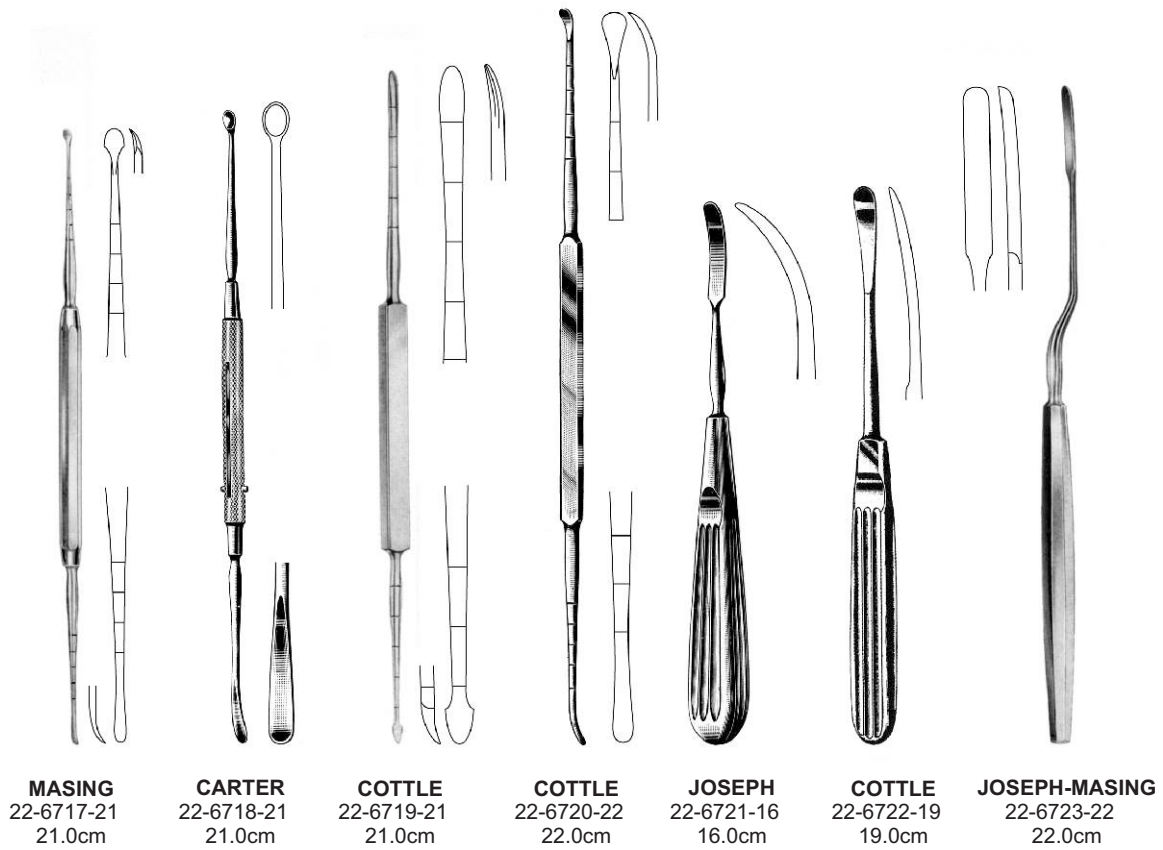

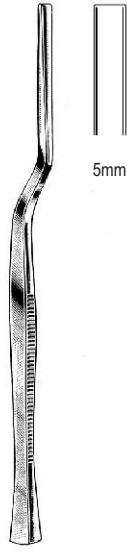

KILLIAN
22-6724-17
17.0cm

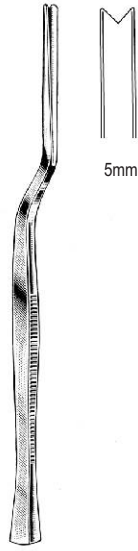

KILLIAN-CLAUS
22-6725-17
17.0cm

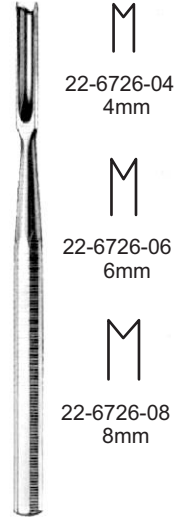

BALLENGER

22-6726-04
4mm

22-6726-06
6mm

22-6726-08
8mm



FREER
22-6727-15
15.0cm



WEST
22-6728-16
16.0cm



WEST
22-6729-16
16.0cm

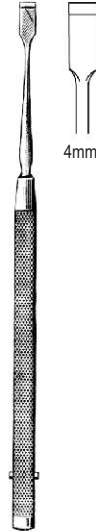

FREER
22-6730-16



FREER
22-6731-16

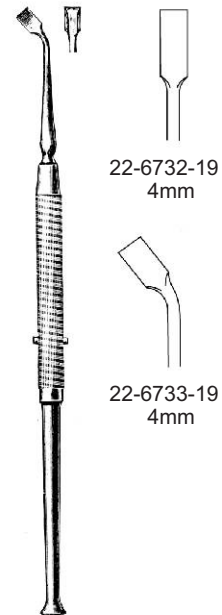

FREER

22-6732-19
4mm

22-6733-19
4mm

RHINOLOGY

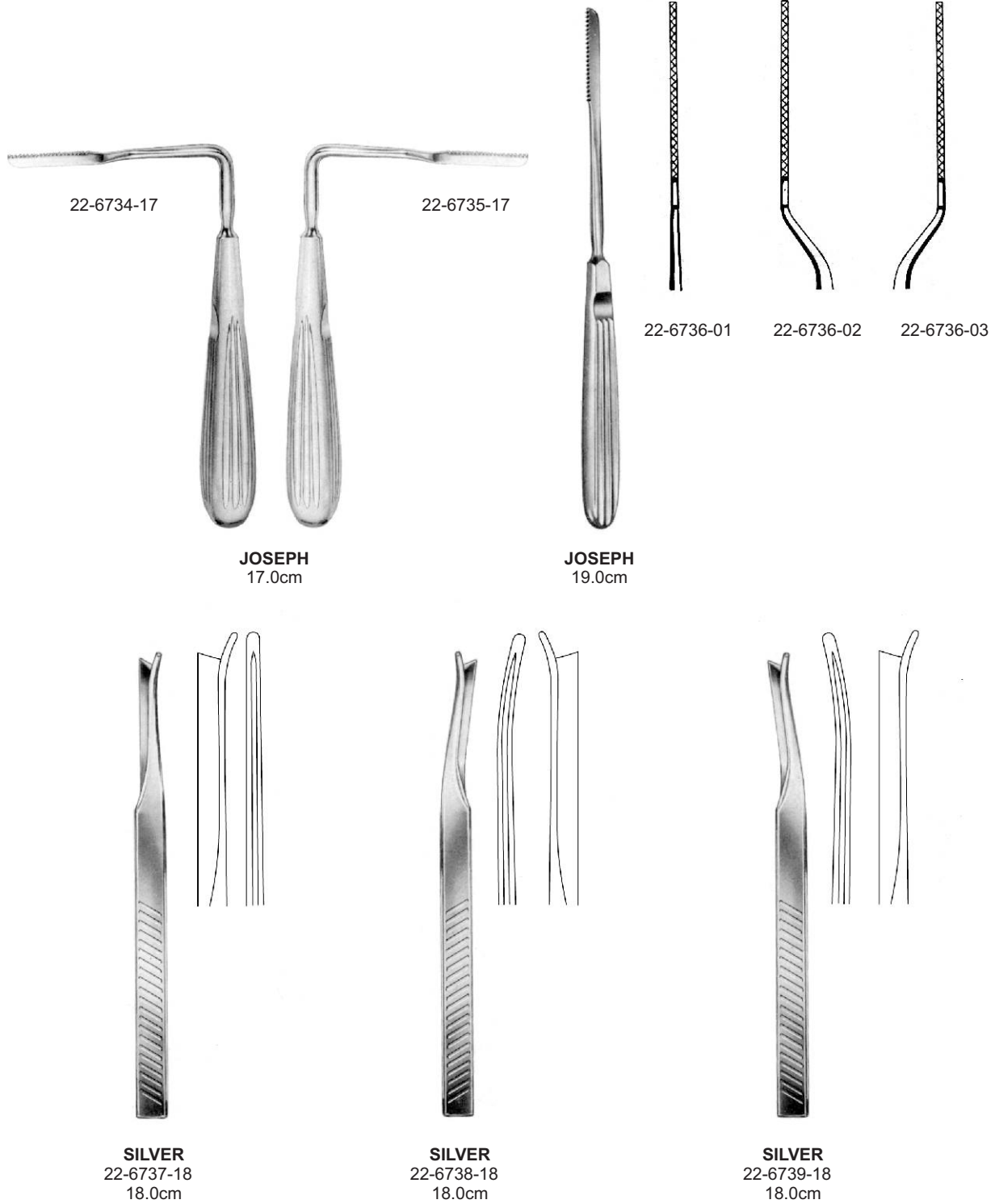

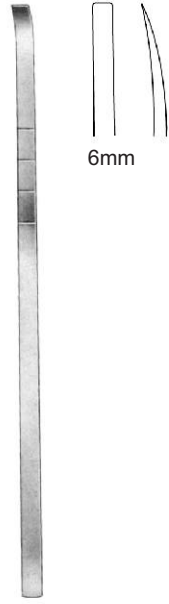

COTTLE
22-6740-18
18.0cm

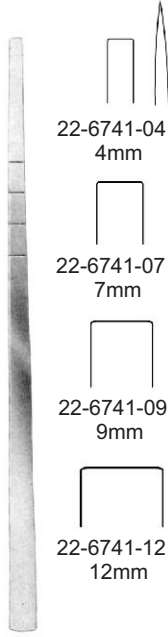

COTTLE
18.0cm

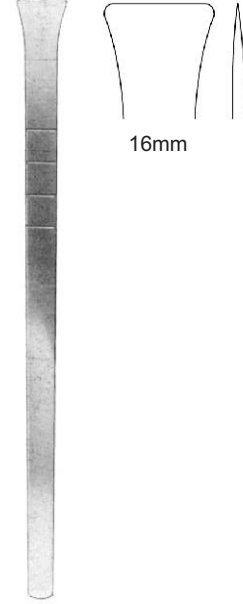

COTTLE
22-6742-18
18.0cm

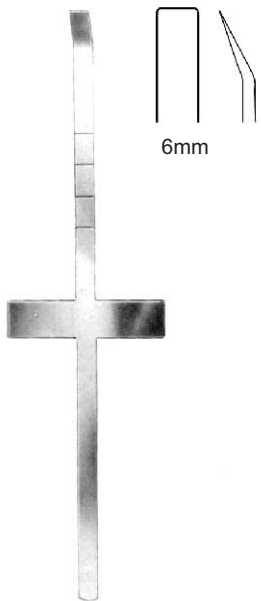

COTTLE
22-6743-18
18.0cm

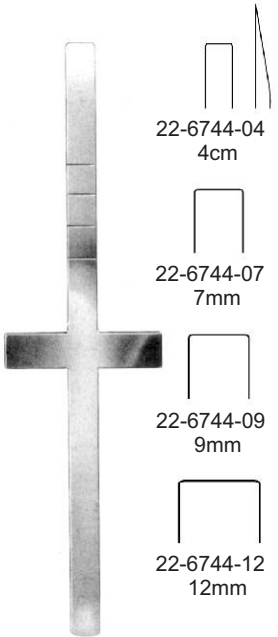

COTTLE
18.0cm

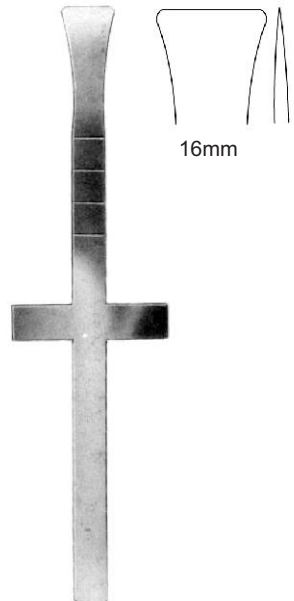

COTTLE
22-6745-18
18.0cm

Osteotomes, Gouges, Chisels
 Osteotome, Hohlmeißel, Meißel
 Osteótomos, guas, cinceles
 Ostéotomes, gouges, ciseaux
 Ostéotomes, sgore, ciseaux

- EN
- DE
- ES
- FR
- IT



FOMON
17.0cm

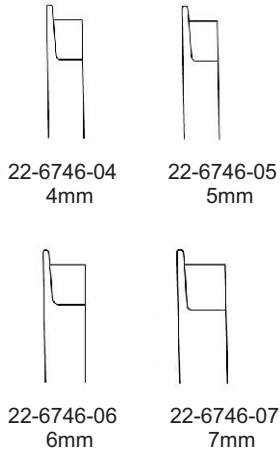

CINELLI
16.0cm

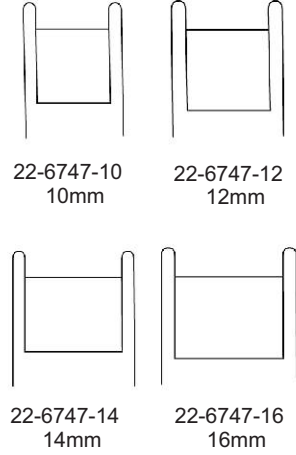

SHEEHAN
17.0cm

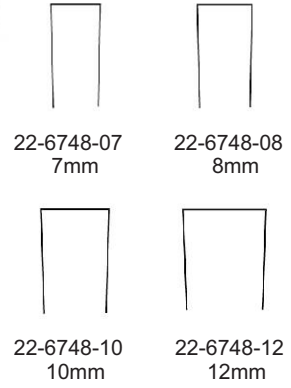

RUN
18.0cm



WALTER
19.0cm

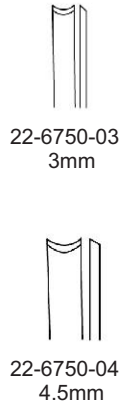

WALTER
19.0cm

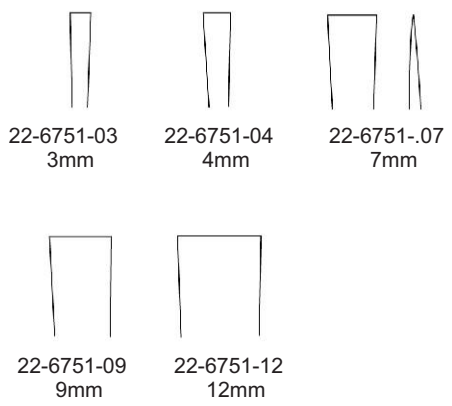

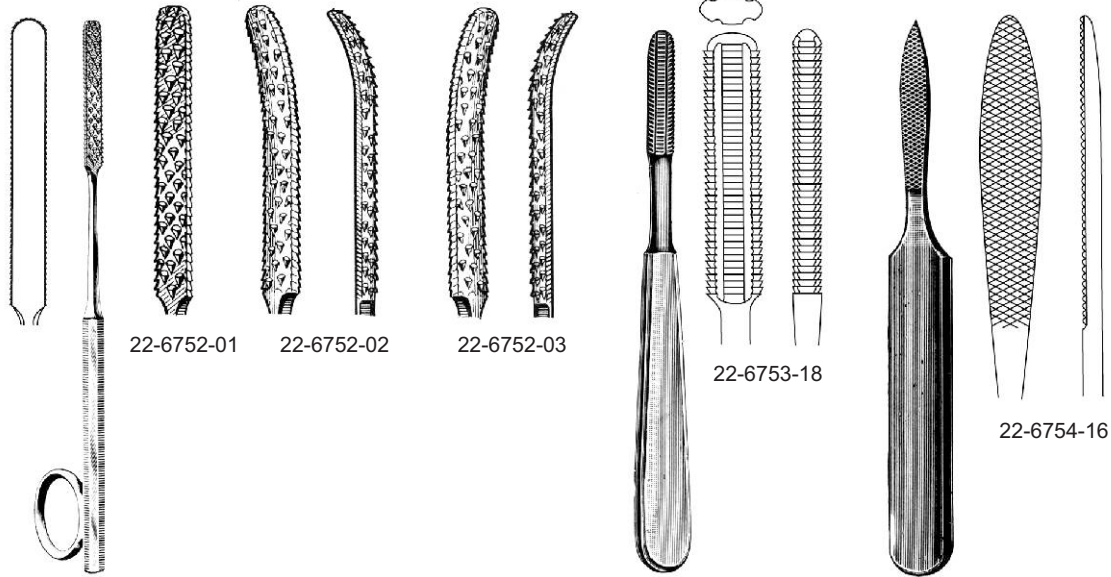

GALLAHER
16.0cm

MALTZ
18.0cm

JOSEPH
16.0cm

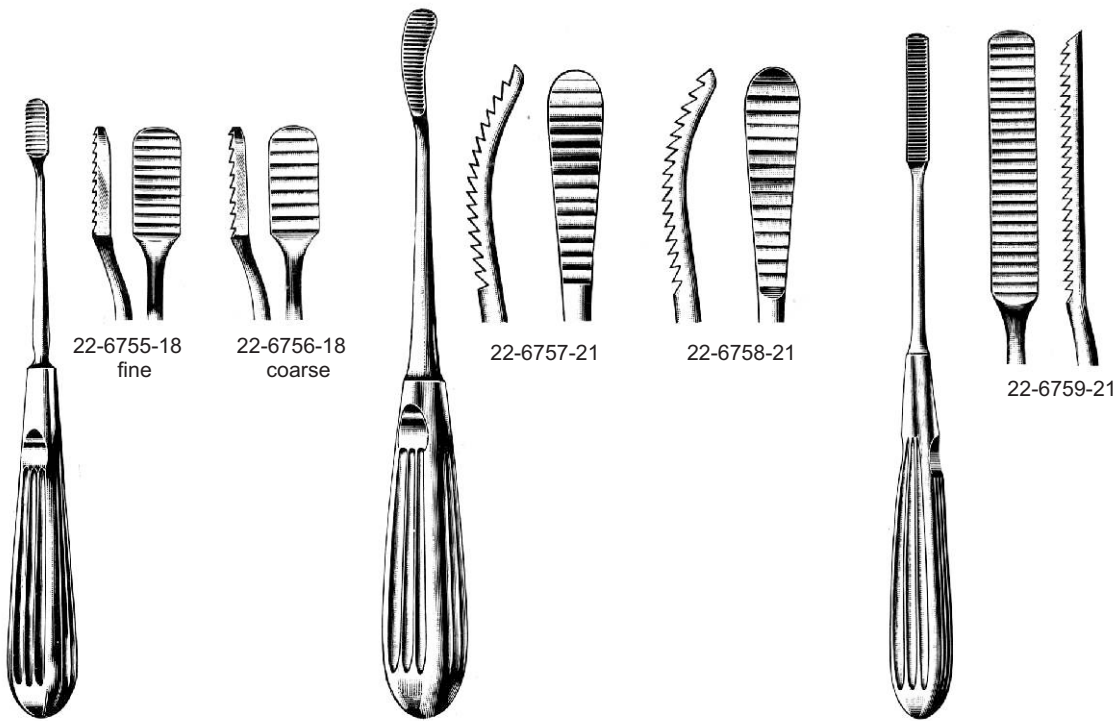

LEWIS
18.0cm

AUFRICHT
21.0cm

COTTLE
21.0cm

Antrum and Nasal Rasps ● EN
 Antrum und Nasenraspeln ● DE
 Escofinas para el antro y nasales ● ES
 Râpes antrales et nasales ● FR
 Antrum e raspe nasali ● IT



WIENER
 18.0cm

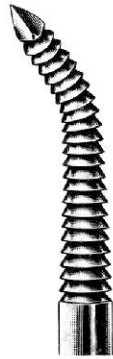

22-6760-18



22-6761-18

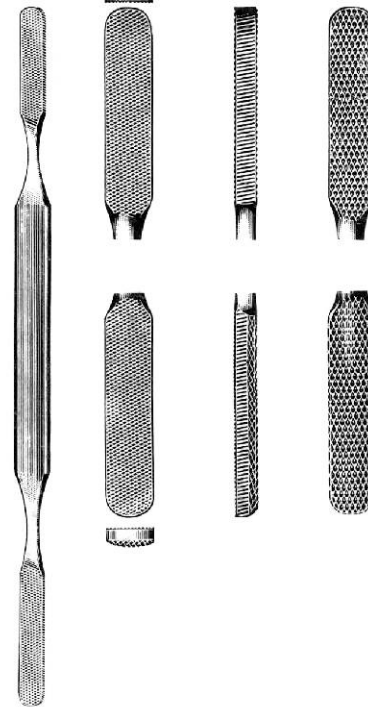

FOMON
 22-6762-21
 21.0cm

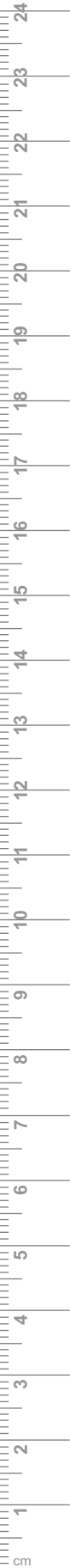

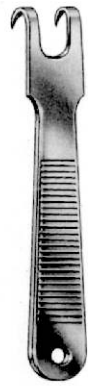

KILNER
22-6763-10
10.0cm



CONVERSE
22-6764-12
12.0cm

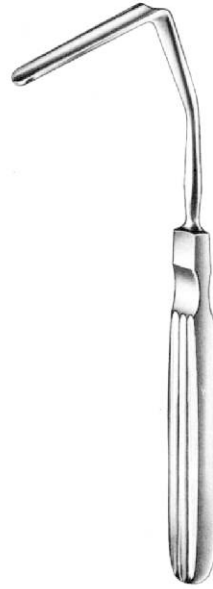

AUFRICHT
22-6765-16
16.0cm

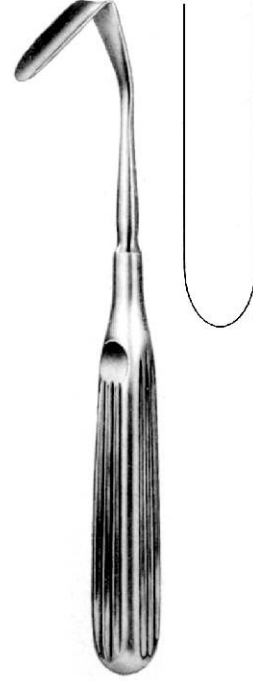

AUFRICHT
22-6766-19
19.0cm



15.0cm



22-6767-01



22-6767-02



22-6767-03



LANGE
22-6768-22
22.0cm



FOMON
22-6769-17
17.0cm



COTTLE
22-6770-16
16.0cm



FREER
22-6771-15
15.0cm



RHINOLOGY



OGURA
 22-6772-11
 11.0cm



COTTLE
 22-6773-11
 11.0cm



COTTLE
 22-6774-14
 14.0cm



COTTLE
 15.0cm

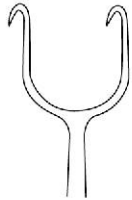

22-6775-14

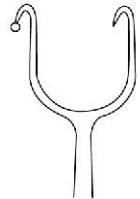

22-6775-01

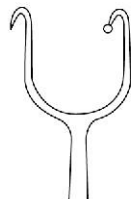

22-6775-02



FOMON
 22-6776-16
 16.0cm

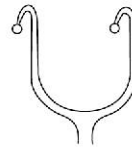

COTTLE-NEIVERT
 22-6777-20
 20.0cm

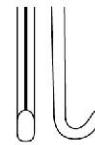



YANKAUER

22-6778-01



22-6778-02



22-6778-03



22-6778-04



22-6778-05



22-6778-06



22-6778-07



22-6778-08



22-6778-09



COTTLE
22-6779-14
14.0cm



NEIVERT
22-6780-16
16.0cm



COTTLE
22-6781-15
15.0cm



COTTLE
22-6782-15
15.0cm



AUFRICHT
22-6783-13
13.5cm



COAKLEY
 17.0cm



MYLES
 17.0cm

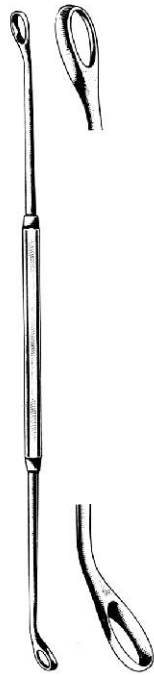

22-6786-12
 12.0cm

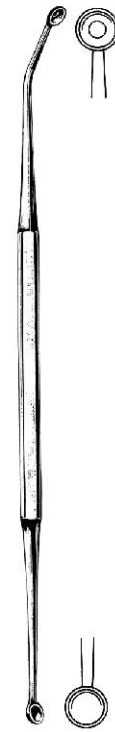

PRATT
 22-6787-21
 21.0cm

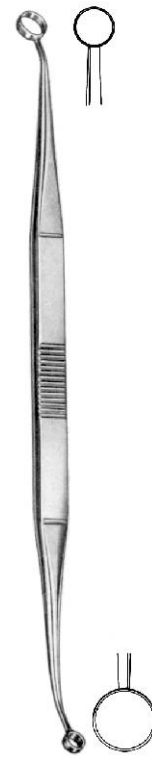

FAULKNER
 22-6788-21
 21.0cm





KRESSNER
22-6789-20
20.0cm

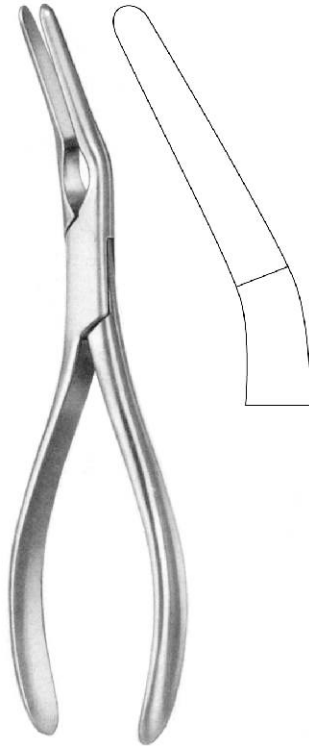

ASCH
22-6790-23
23.0cm

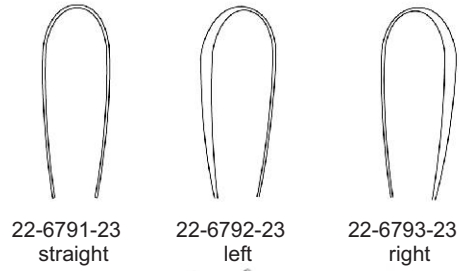

COTTLE-WALSHAM
23.0cm

Adenoid Curettes — EN
 Ringmesser — DE
 Cuchillos para vegetaciones adenoides — ES
 Curettes adénoïdes — FR
 Curette adénoïdi — IT



BECKMANN
22.0cm



BECKMANN
22.0cm



22-6794-01
22-6795-01



22-6794-02
22-6795-02

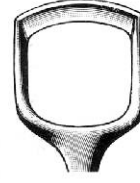

22-6794-03
22-6795-03



22-6794-04
22-6795-04



22-6794-05
22-6795-05

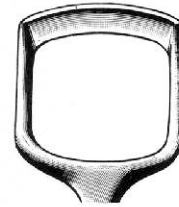

22-6794-06
22-6795-06



BECKMANN
22.0cm



22-6796-01

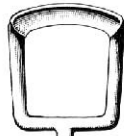

22-6796-02

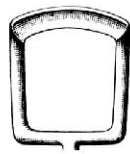

22-6796-03

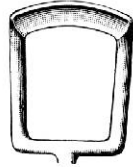

22-6796-04

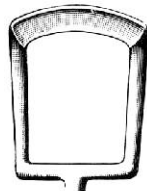

22-6796-05



ST.CLAIR-THOMSON
21.0cm



22-6797-08
8mm



22-6797-10
10mm



22-6797-12
12mm

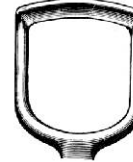

22-6797-14
14mm

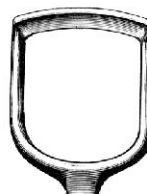

22-6797-16
16mm

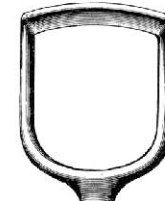

22-6797-18
18mm





BRUENINGS-BRUNK
22-6798-21
21.5cm

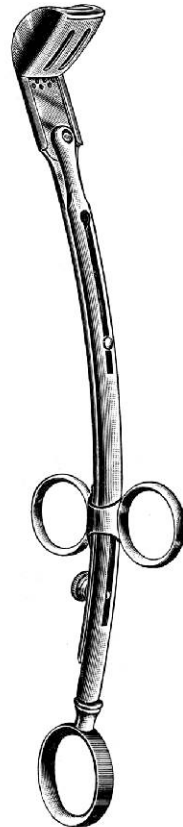

LA FORCE
25.0cm

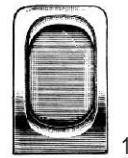

1

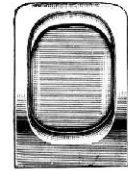

2

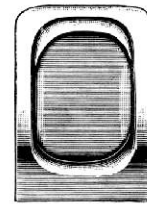

3

with unperforated blade
22-6799-01 Fig. 1
22-6799-02 Fig. 2
22-6799-03 Fig. 3

spare blades
22-6801-01 Fig. 1
22-6801-02 Fig. 2
22-6801-03 Fig. 3

with perforated blade
22-6800-01
22-6800-02
22-6800-03

22-6802-01
22-6802-02
22-6802-03

Antrum and Frontal Sinus Wash Cannulas
 Kiefer-und Stirnhohlen-Spulkanulen
 Canulas lavadoras para senos maxilar y frontal
 Canules de lavage de l'antre et du sinus frontal
 Cannule per lavaggio antrum e seno frontale

- EN
- DE
- ES
- FR
- IT

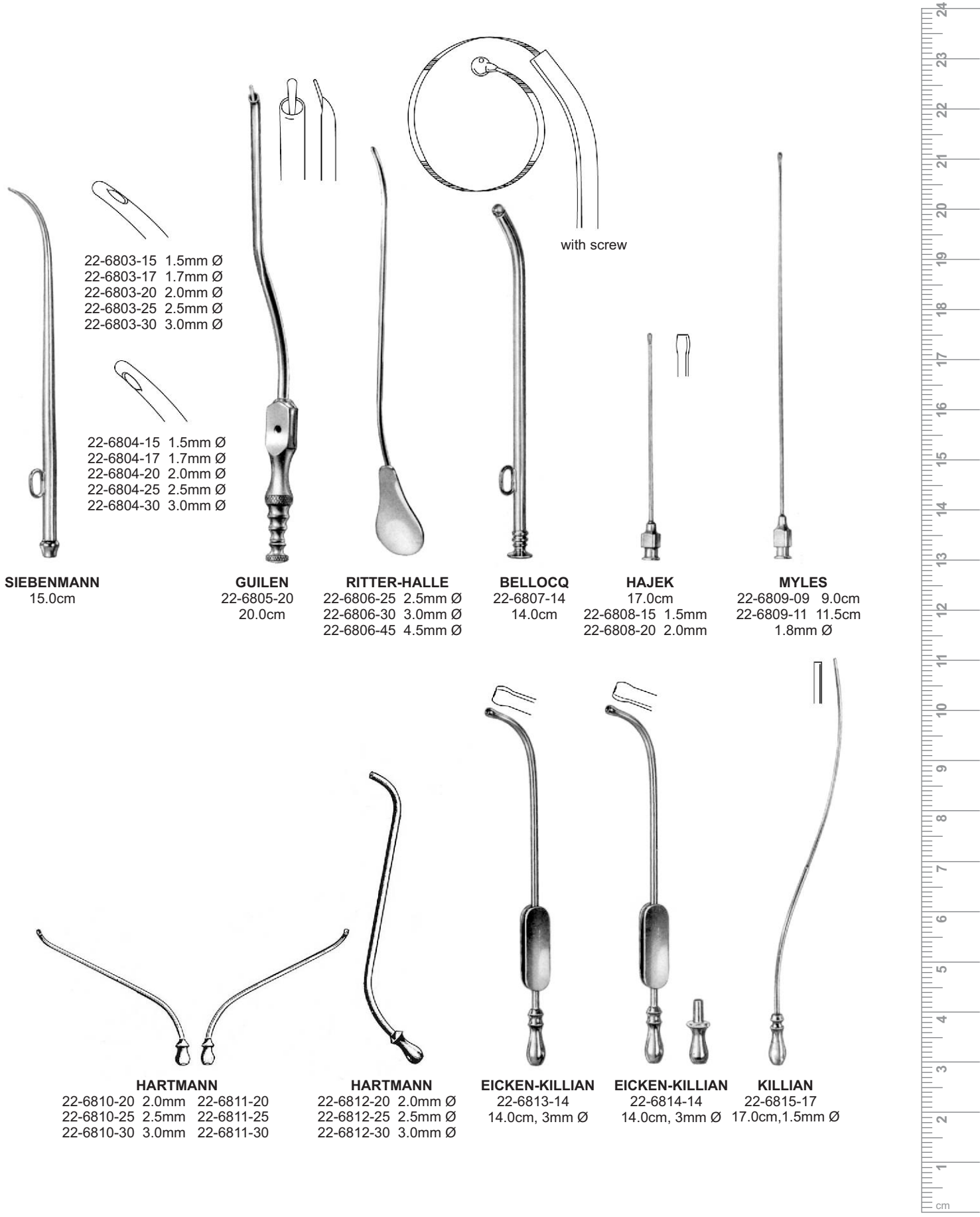

SIEBENMANN
15.0cm

- 22-6803-15 1.5mm Ø
- 22-6803-17 1.7mm Ø
- 22-6803-20 2.0mm Ø
- 22-6803-25 2.5mm Ø
- 22-6803-30 3.0mm Ø

- 22-6804-15 1.5mm Ø
- 22-6804-17 1.7mm Ø
- 22-6804-20 2.0mm Ø
- 22-6804-25 2.5mm Ø
- 22-6804-30 3.0mm Ø

GULEN
22-6805-20
20.0cm

RITTER-HALLE
22-6806-25 2.5mm Ø
22-6806-30 3.0mm Ø
22-6806-45 4.5mm Ø

BELLOCQ
22-6807-14
14.0cm

HAJEK
17.0cm
22-6808-15 1.5mm
22-6808-20 2.0mm

MYLES
22-6809-09 9.0cm
22-6809-11 11.5cm
1.8mm Ø

HARTMANN
22-6810-20 2.0mm 22-6811-20
22-6810-25 2.5mm 22-6811-25
22-6810-30 3.0mm 22-6811-30

HARTMANN
22-6812-20 2.0mm Ø
22-6812-25 2.5mm Ø
22-6812-30 3.0mm Ø

EICKEN-KILLIAN
22-6813-14
14.0cm, 3mm Ø

EICKEN-KILLIAN
22-6814-14
14.0cm, 3mm Ø

KILLIAN
22-6815-17
17.0cm, 1.5mm Ø