

- EN** Cardiovascular Surgery
- DE** Herz- und Gefäßchirurgie
- ES** Cirugía cardiovascular
- FR** Chirurgie cardiovasculaire
- IT** Chirurgia cardiovascolare

**Page 388 to 498**

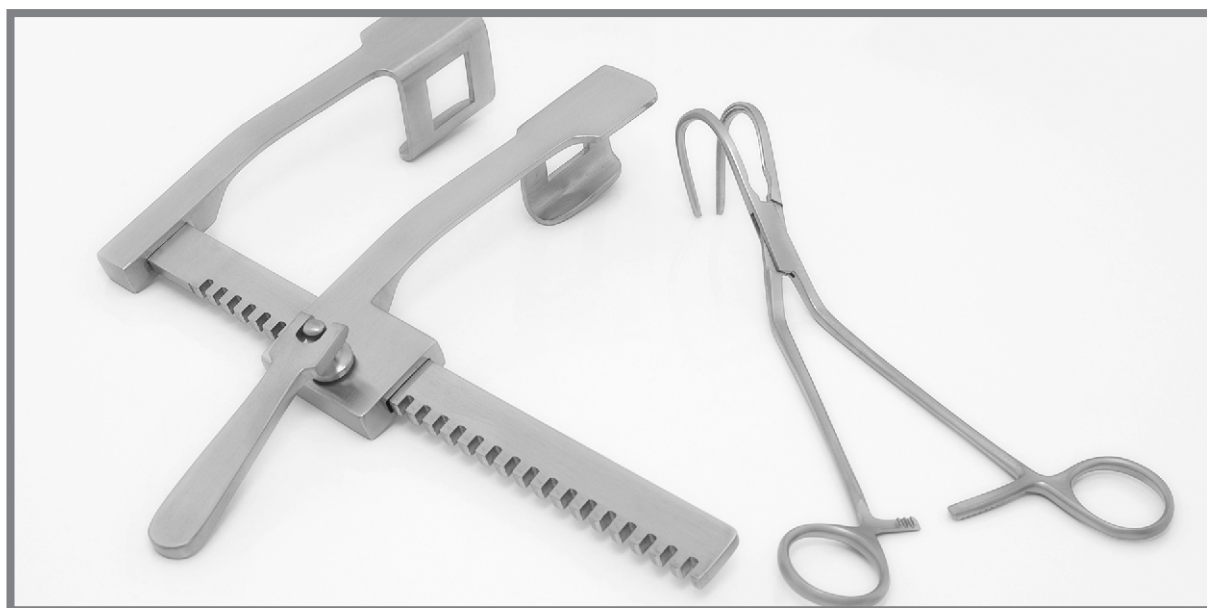



1.5 mm

BI 19-5501-12 12.5cm  
BI 19-5501-15 15cm

**DEBAKEY-ADSON**



1.0 mm

BI 19-5502-15 15.0cm  
BI 19-5502-18 18.0cm



1.2 mm

BI 19-5503-15 15.0cm  
BI 19-5503-18 18.0cm  
BI 19-5503-24 24.0cm

**DEBAKEY-GERALD**



1.0mm

BI 19-5504-18 18.0cm

**DEBAKEY-CUSHING**

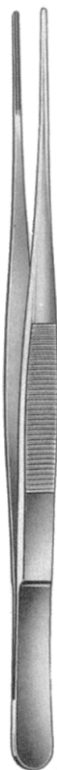

1.0mm

BI 19-5505-15 15.0cm BI 19-5506-15  
BI 19-5505-19 19.0cm BI 19-5506-19  
BI 19-5505-24 24.0cm BI 19-5506-24

**DEBAKEY-DIETRICH**



1.0mm

BI 19-5507-15 15.0cm  
BI 19-5507-19 19.0cm  
BI 19-5507-24 24.0cm

**DEBAKEY-LIGHT**

Also available in titanium

1.5 mm



**DE BAKEY**

- BI 19-5508-16 16.0cm
- BI 19-5508-20 20.0cm
- BI 19-5508-24 24.0cm
- BI 19-5508-30 30.0cm

2.0 mm

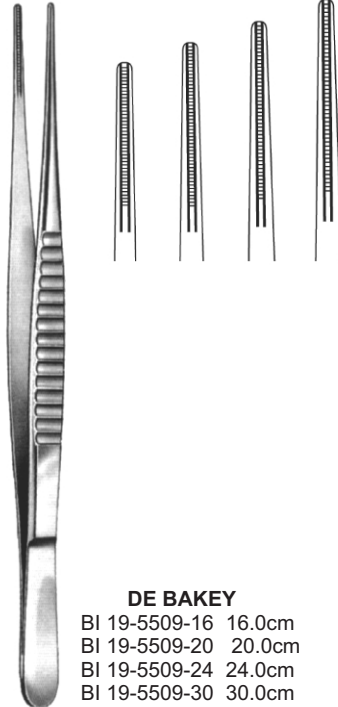

**DE BAKEY**

- BI 19-5509-16 16.0cm
- BI 19-5509-20 20.0cm
- BI 19-5509-24 24.0cm
- BI 19-5509-30 30.0cm

2.7 mm

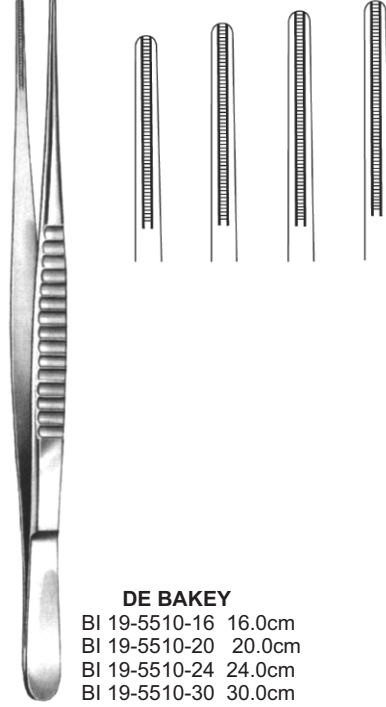

**DE BAKEY**

- BI 19-5510-16 16.0cm
- BI 19-5510-20 20.0cm
- BI 19-5510-24 24.0cm
- BI 19-5510-30 30.0cm

3.5mm

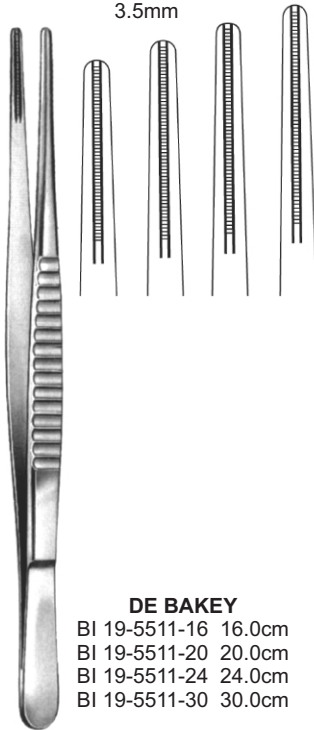

**DE BAKEY**

- BI 19-5511-16 16.0cm
- BI 19-5511-20 20.0cm
- BI 19-5511-24 24.0cm
- BI 19-5511-30 30.0cm

2mm

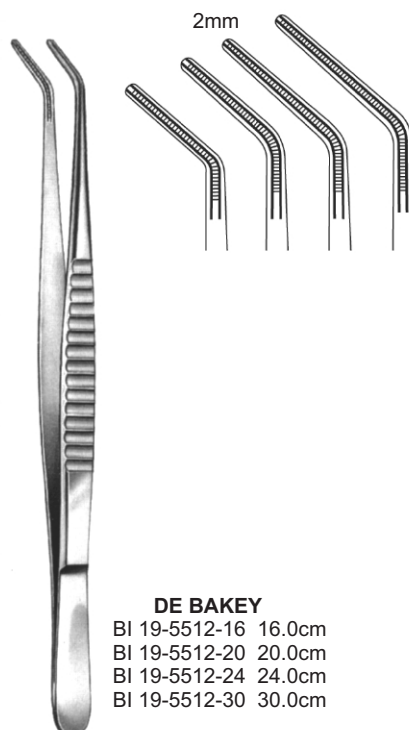

**DE BAKEY**

- BI 19-5512-16 16.0cm
- BI 19-5512-20 20.0cm
- BI 19-5512-24 24.0cm
- BI 19-5512-30 30.0cm

2.7mm



**DE BAKEY**

- BI 19-5513-16 16.0cm
- BI 19-5513-20 20.0cm
- BI 19-5513-24 24.0cm
- BI 19-5513-30 30.0cm



Also available in titanium



**MINI-GLOVER**

BI 19-5514-03 3.5cm BI 19-5515-03  
BI 19-5514-04 4.5cm BI 19-5515-04



BI 19-5516-03 3.5cm BI 19-5517-03

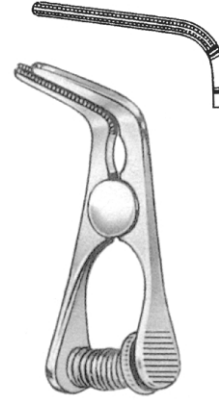

**GLOVER**  
BI 19-5518-05  
5.0cm

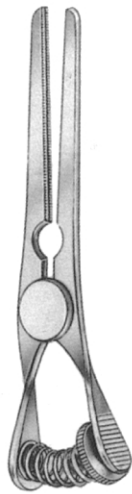

**GLOVER (DELICATE)**

BI 19-5519-05 5.0cm BI 19-5519-06 6.8cm  
BI 19-5519-08 8.5cm

BI 19-5520-05 4.6cm BI 19-5520-06 6.4cm  
BI 19-5520-08 7.8cm



Also available in titanium

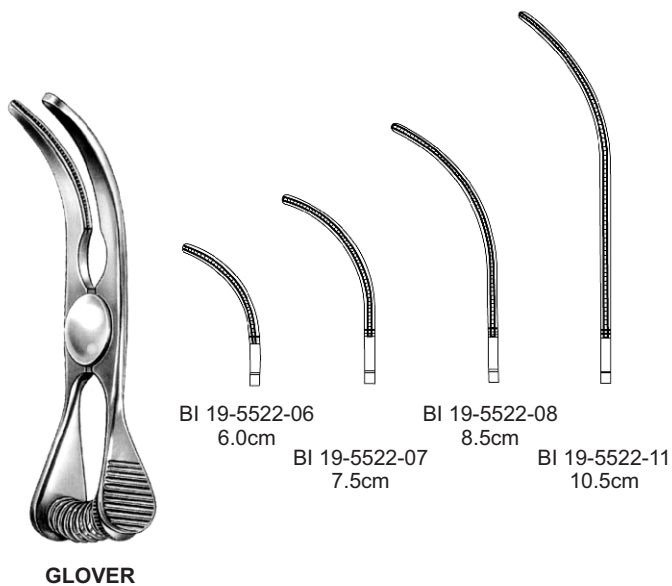
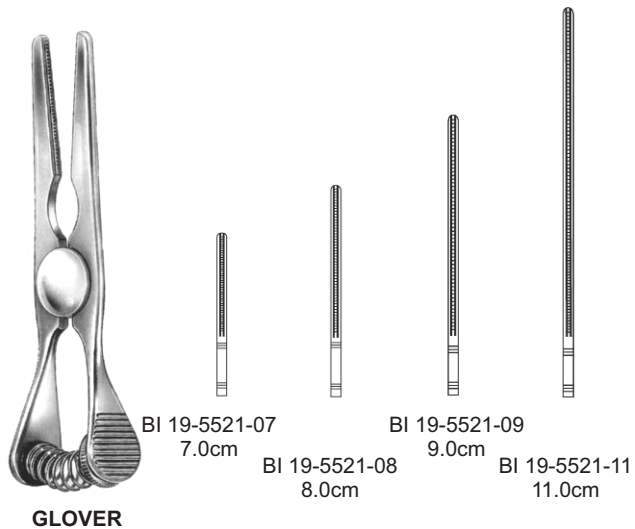

Also available in titanium



DE BAKEY



BI 19-5529-07  
7.5cm

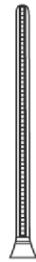

BI 19-5529-08  
8.5cm



BI 19-5529-10  
10.5cm



BI 19-5529-12  
12.0cm

Also available in titanium

DE BAKEY



DE BAKEY

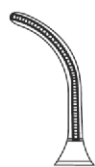

BI 19-5530-07  
7.0cm



BI 19-5530-08  
8.0cm

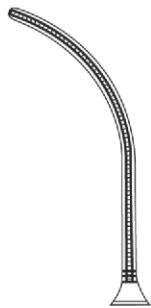

BI 19-5530-10  
10.0cm



BI 19-5530-11  
11.5cm

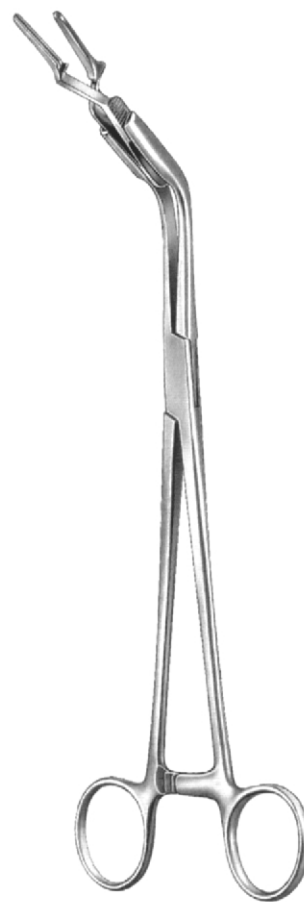

BI 19-5531-23  
23.0cm



Also available in titanium

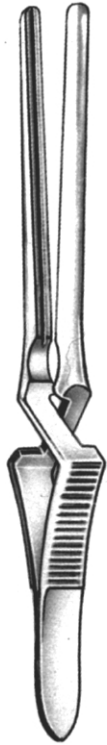

GREGORY SOFT

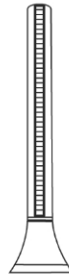

BI 19-5532-09  
9.0cm

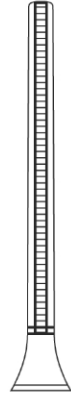

BI 19-5532-11  
11.0cm



GREGORY SOFT



BI 19-5533-09  
9.0cm

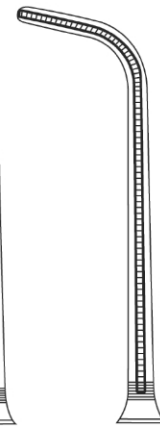

BI 19-5533-11  
11.0cm



GREGORY SOFT  
11.0cm



BI 19-5534-01

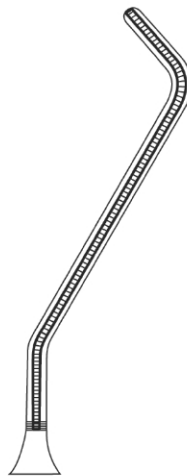

BI 19-5534-02



SANTULLI  
BI 19-5535-07  
7.0cm

Also available in titanium



**DE BAKEY-SATINSKY**  
 BI 19-5536-07  
 7.0cm

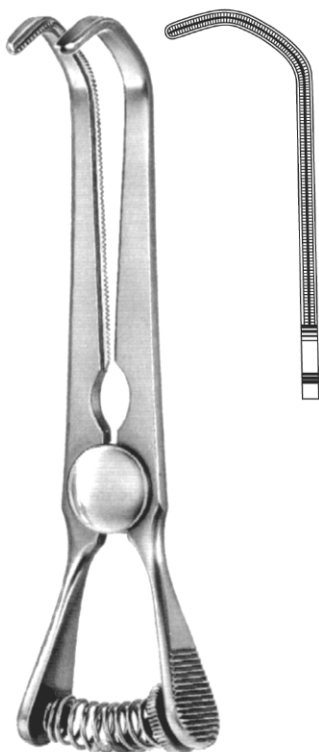

**DE BAKEY-SATINSKY**  
 BI 19-5537-10  
 10.0cm

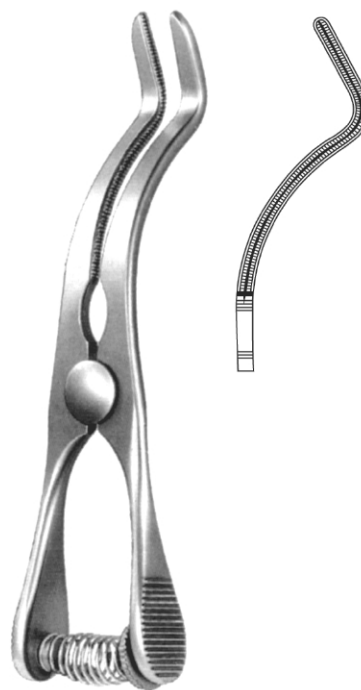

**DE BAKEY-CAROTIS**  
 BI 19-5538-09  
 9.0cm



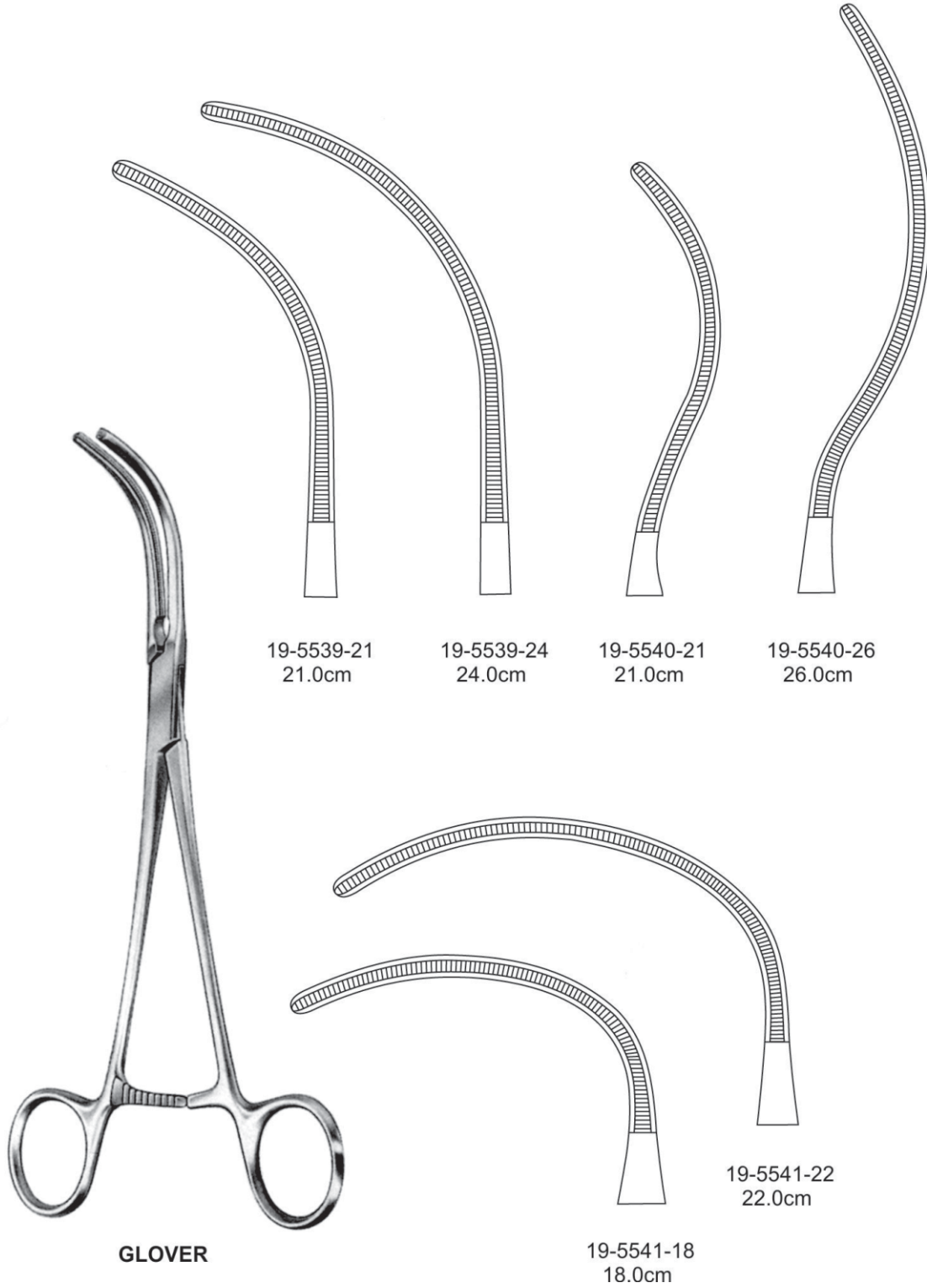

19-5539-21  
21.0cm

19-5539-24  
24.0cm

19-5540-21  
21.0cm

19-5540-26  
26.0cm

GLOVER

19-5541-18  
18.0cm

19-5541-22  
22.0cm

Dissecting and  
 Ligature Forceps

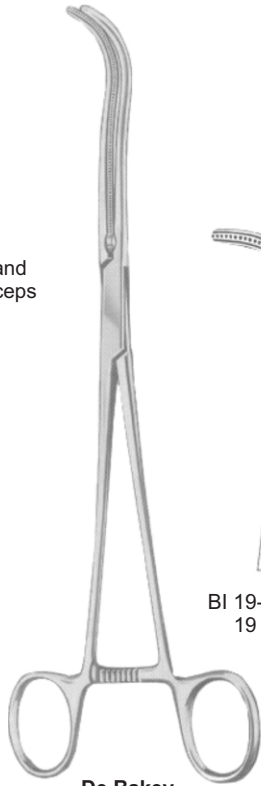

De Bakey

BI 19-5543-19  
 19 cm/8"

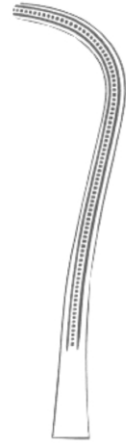

BI 19-5543-23  
 23 cm/9 1/2"



De Bakey

BI 19-5544-20  
 20 cm/8"

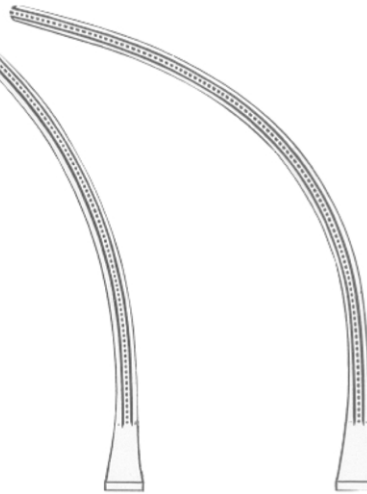

BI 19-5544-18  
 18 cm/7 1/2"



De Bakey



BI 19-5545-01  
 19.5 cm/7 1/2"



BI 19-5545-02  
 19.5 cm/7 1/2"

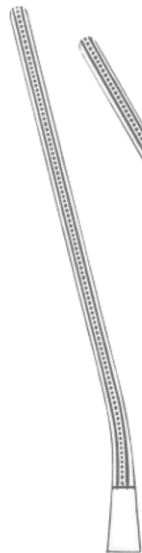

BI 19-5545-03  
 19.5 cm/7 1/2"

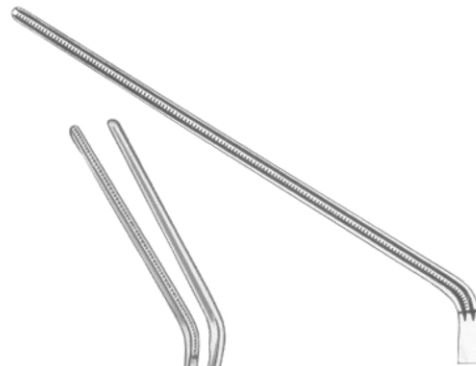

Leland-Jones  
 BI 19-5546-18  
 18 cm/7"





Aortic Aneurysm Clamps



De Bakey



De Bakey



BI 19-5547-24  
26 cm/10 1/2"



BI 19-5547-27  
27 cm/10 1/2"



BI 19-5547-31  
31 cm/12 1/4"



BI 19-5547-33  
33 cm/13 1/4"



De Bakey-Bainbirdge



BI 19-5548-15  
15 cm/6"



BI 19-5548-18  
18 cm/7"



BI 19-5549-15  
15 cm/6"



BI 19-5549-18  
18 cm/7"



De Bakey  
BI 19-5549-20  
20 cm/8"





De Bakey

Aortic Aneurysm Clamps

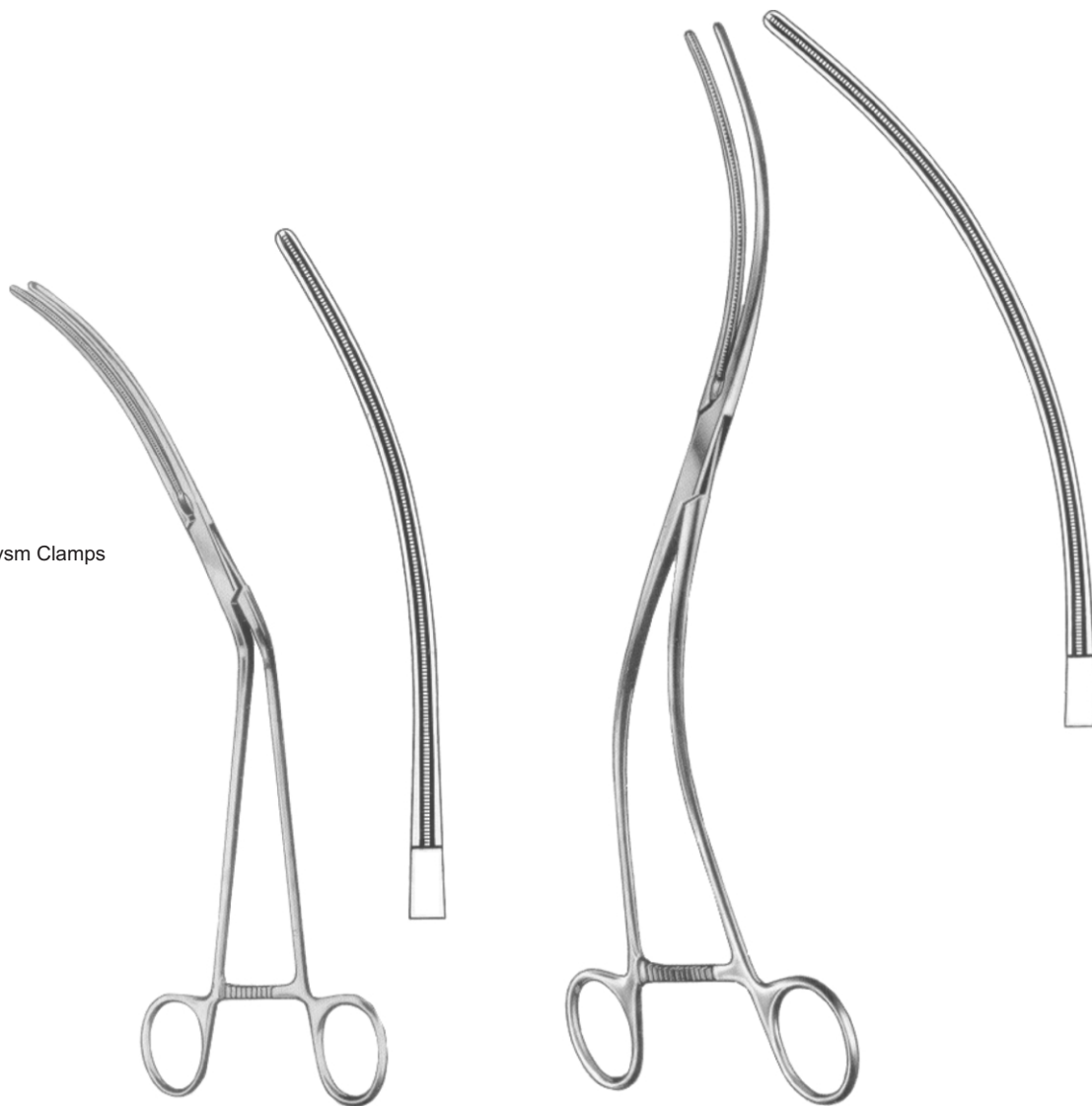

**De Bakey**  
 BI 19-5550-28  
 28 cm/11"

BI 19-5551-30  
 30 cm/12"





De Bakey

Aortic Clamps

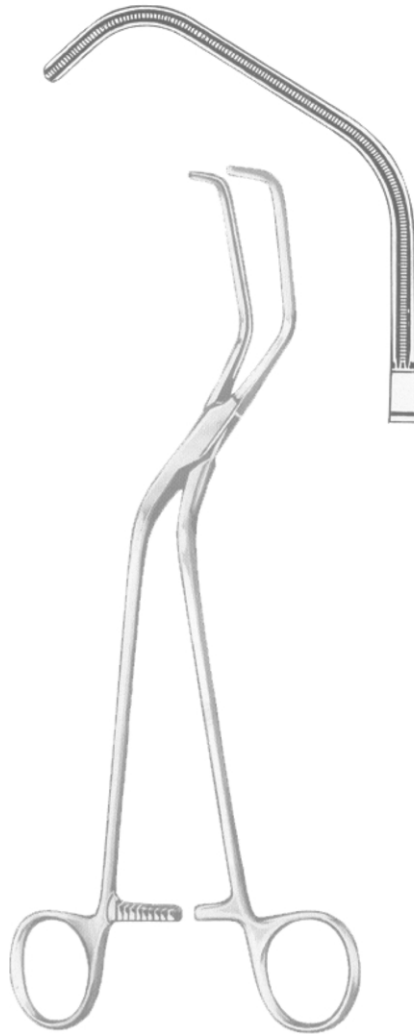

**Ochsner**  
BI 19-5552-23  
23.5 cm/9¼"

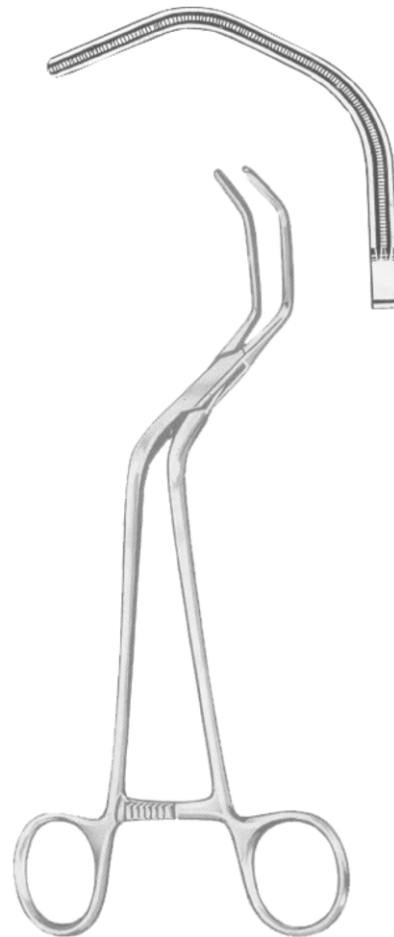

**Dietrich**  
BI 19-5553-21  
21 cm/8¼"



De Bakey

Auricle Clamp



Harken



BI 19-5554-01  
 24 cm/9½"



BI 19-5554-02  
 24 cm/9½"



BI 19-5554-03  
 24 cm/9½"



BI 19-5554-04  
 24 cm/9½"





De Bakey

Bronchus Clamps



BI 19-5558-23  
23 cm/9"

BI 19-5559-25  
25 cm/10"



Lees



Lees  
BI 19-5560-25  
25 cm/10"



De Bakey

Aortic Clamp

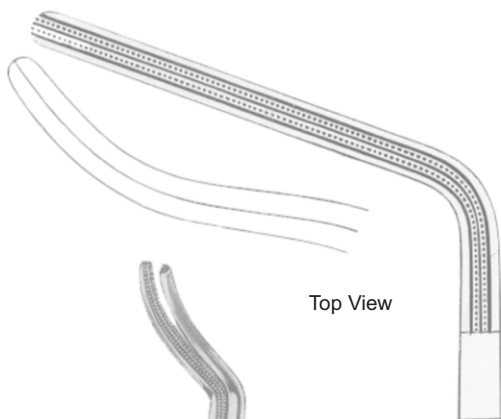

Top View



**De Bakey**  
 BI 19-5561-27  
 27 cm/10½"

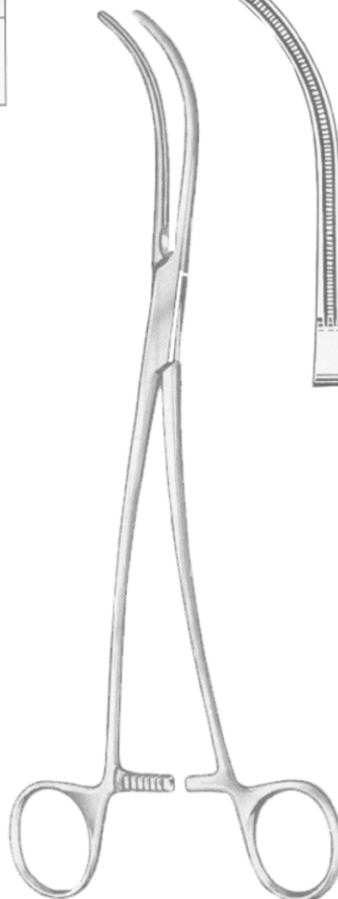

**De Bakey**  
 BI 19-5562-24  
 24 cm/9½"

Ligature Clamps

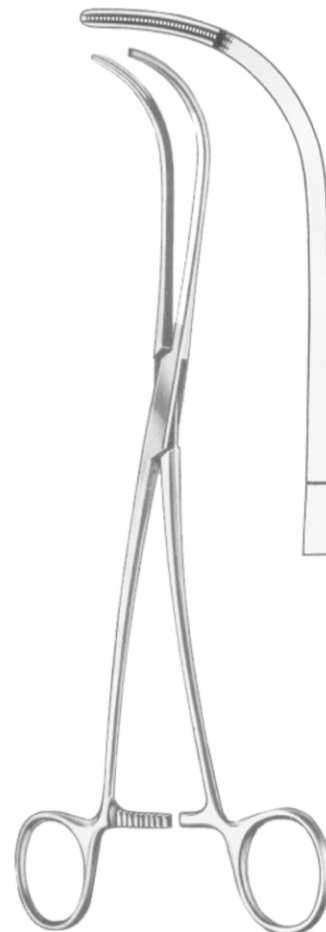

**De Bakey**  
 BI 19-5563-24  
 24 cm/9½"





De Bakey

Ligature clamp,  
Aortic clamp

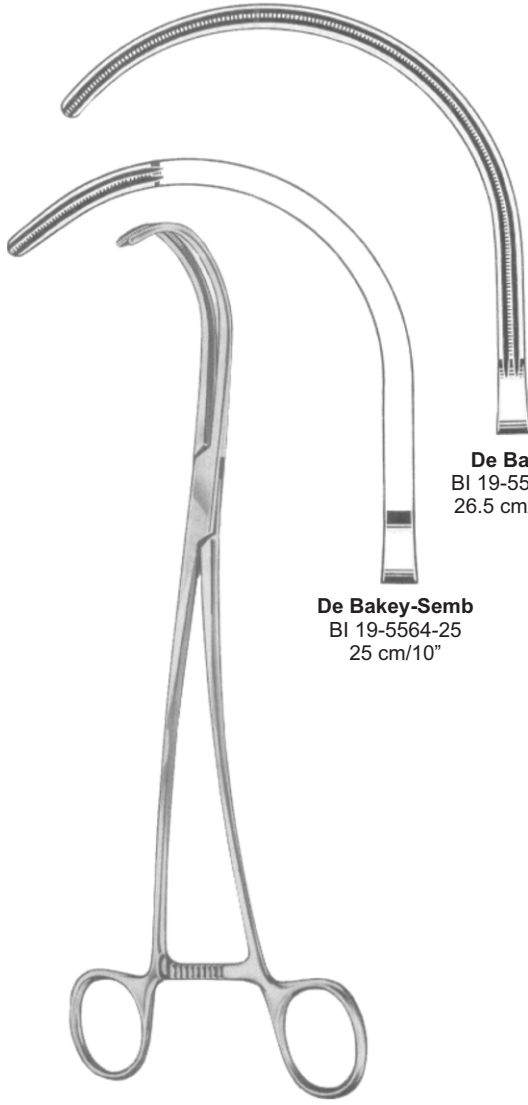

**De Bakey**  
BI 19-5564-26  
26.5 cm/10½"

**De Bakey-Semb**  
BI 19-5564-25  
25 cm/10"

**De Bakey-Semb**

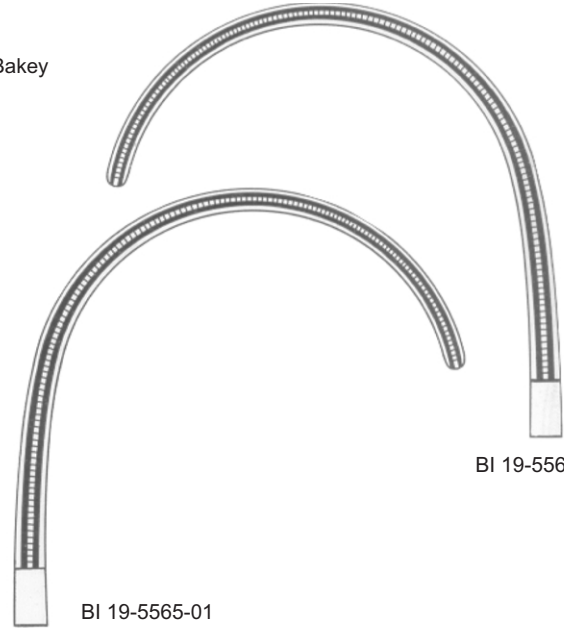

BI 19-5565-02

BI 19-5565-01

Aortic clamp

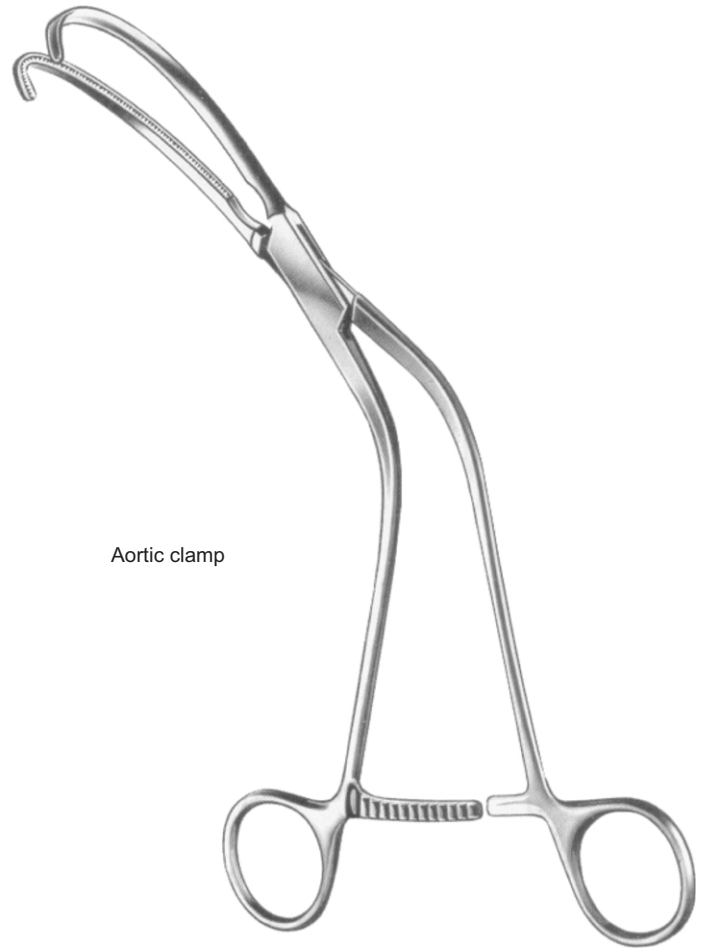

**Weber**  
26 cm/10¼"



Satinsky/De Bakey

Tangential occlusion clamps



De Bakey

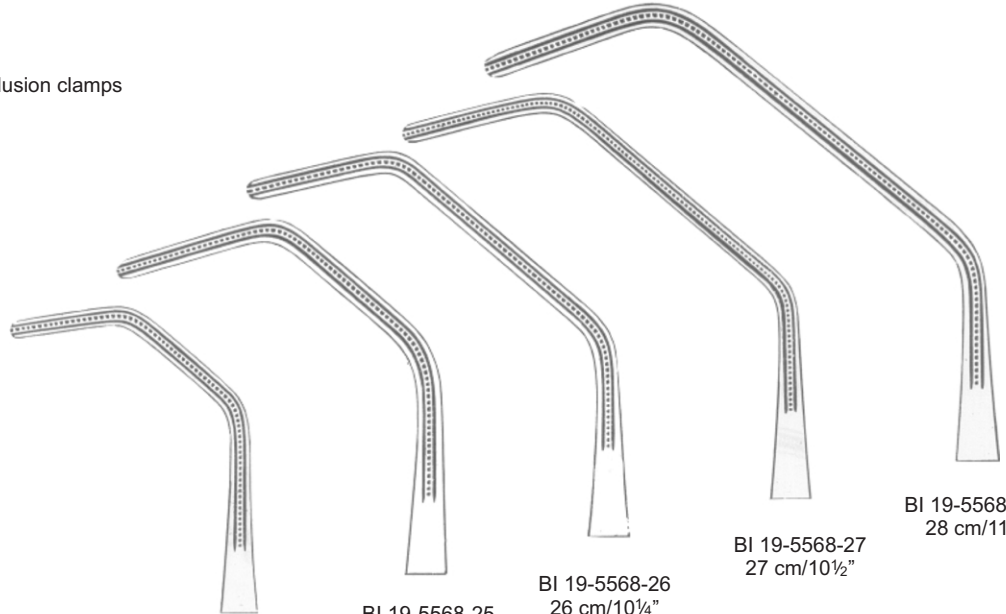

Set of 5 purchase.  
 BI 19-5568-00

BI 19-5568-20  
 20 cm/8"

BI 19-5568-25  
 25 cm/10"

BI 19-5568-26  
 26 cm/10¼"

BI 19-5568-27  
 27 cm/10½"

BI 19-5568-28  
 28 cm/11"



Glover

BI 19-5569-01 19.5 cm/7¾"  
 BI 19-5569-02 21.0 cm/8¼"

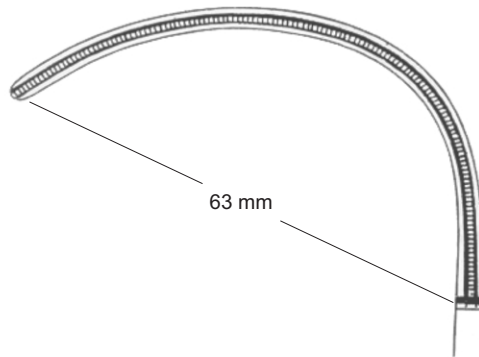

Anastomosis

63 mm

BI 19-5569-01

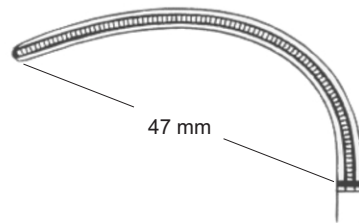

47 mm

BI 19-5569-02





De Bakey



**De Bakey**  
BI 19-5570-16  
16 cm/6 1/4"

Graduated

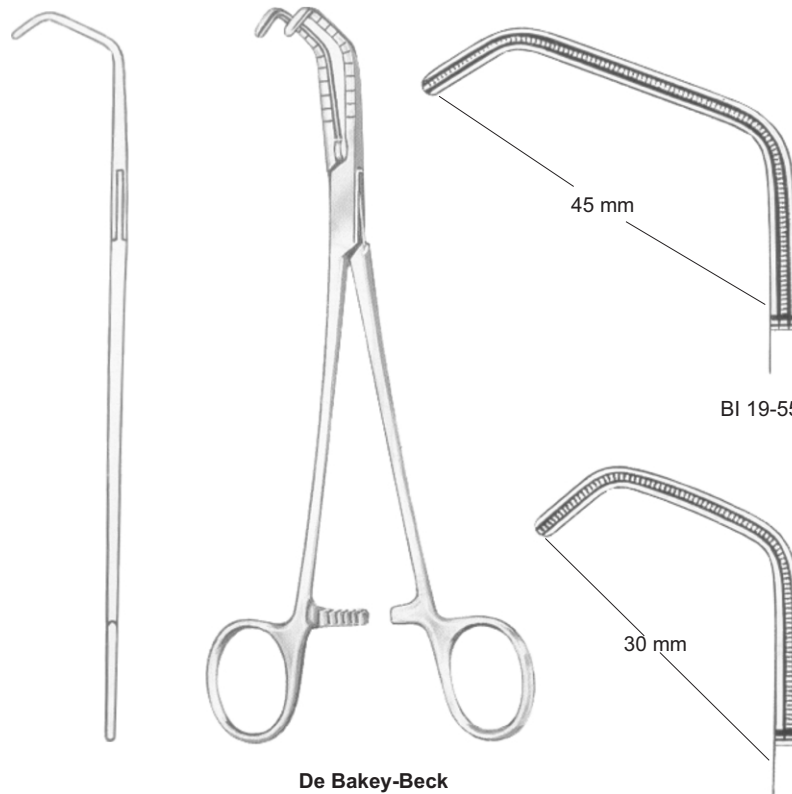

**De Bakey-Beck**  
BI 19-5571-01 20.5 cm/8"  
BI 19-5571-02 21.0 cm/8 1/4"

BI 19-5571-02

BI 19-5571-01





De Bakey



**Lambert-Kay**  
 21 cm/8¼"

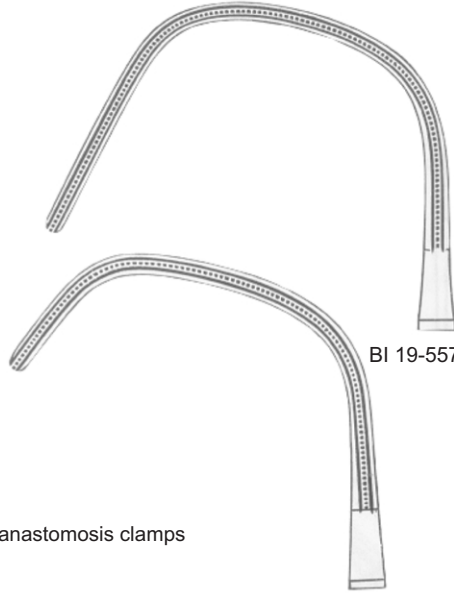

Aortic anastomosis clamps

BI 19-5572-21

BI 19-5572-22

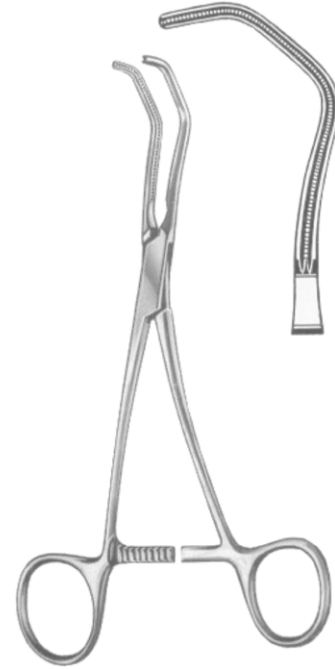

**De Bakey**  
 BI 19-5573-17  
 17 cm/6¾"



**Beck**  
 BI 19-5574-17  
 17 cm/6¾"



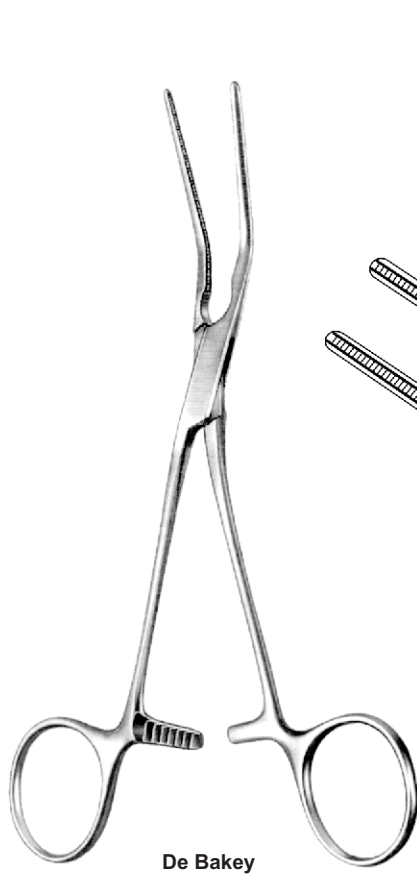

BI 19-5575-20  
20 cm/8"

BI 19-5575-22  
22 cm/8 3/4"

BI 19-5575-24  
24 cm/9 1/2"

BI 19-5575-30  
30.5 cm/12"

Multi purpose clamps

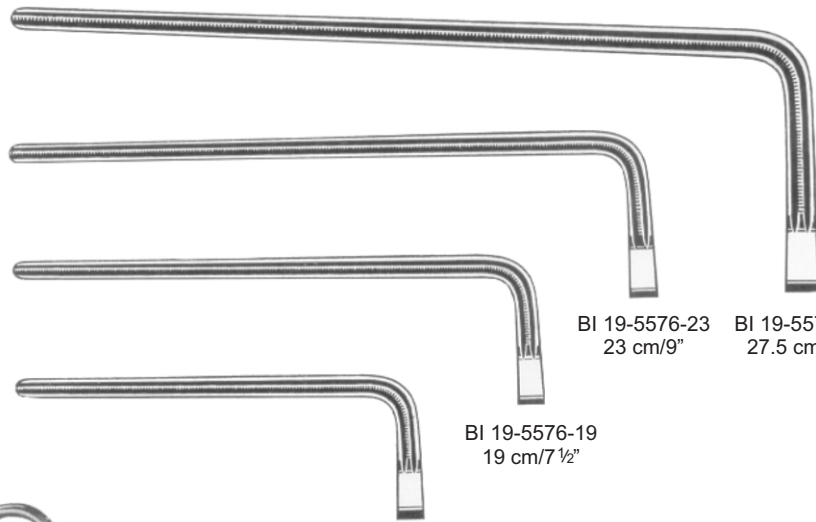
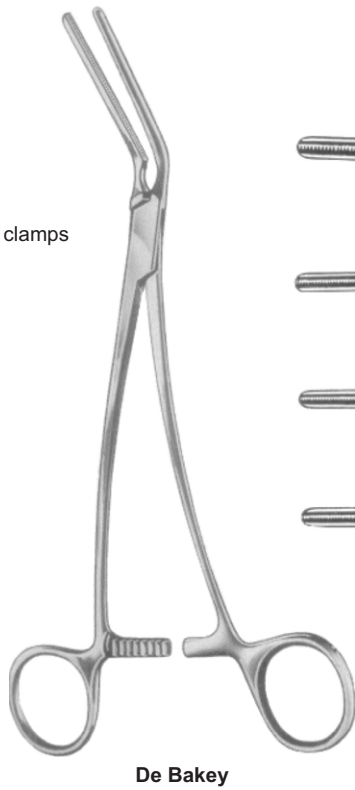

BI 19-5576-18  
18 cm/7"

BI 19-5576-19  
19 cm/7 1/2"

BI 19-5576-23  
23 cm/9"

BI 19-5576-27  
27.5 cm/11"

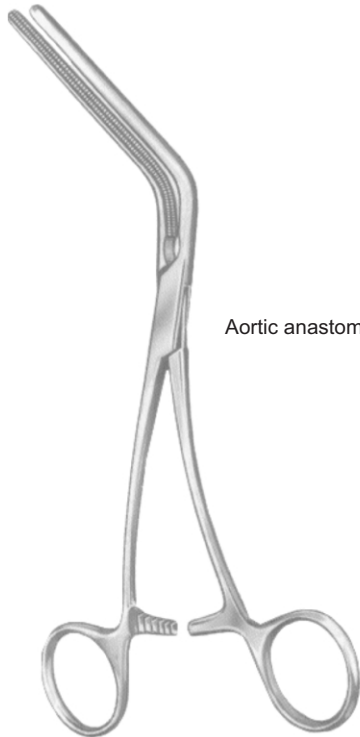

Aortic anastomosis clamps

**Morris-De Bakey**

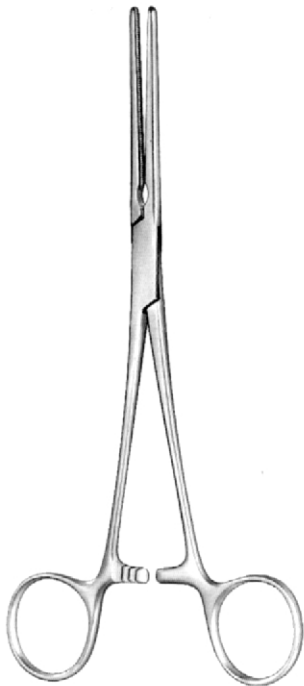
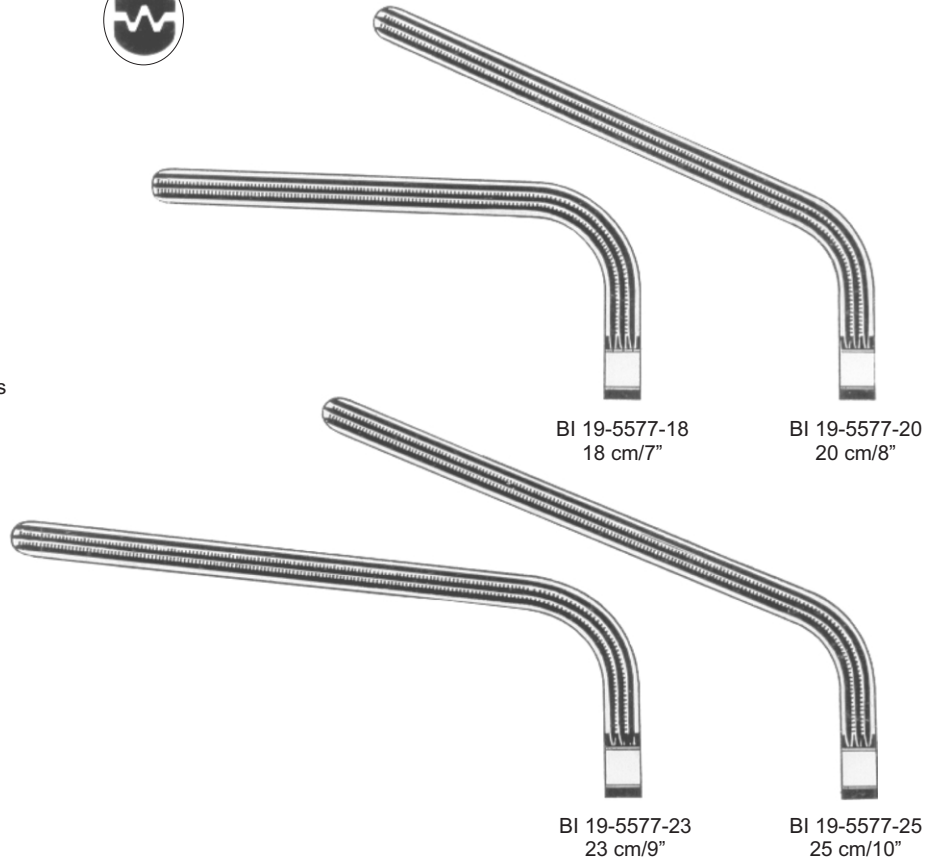

**DE BAKEY-PEAN**

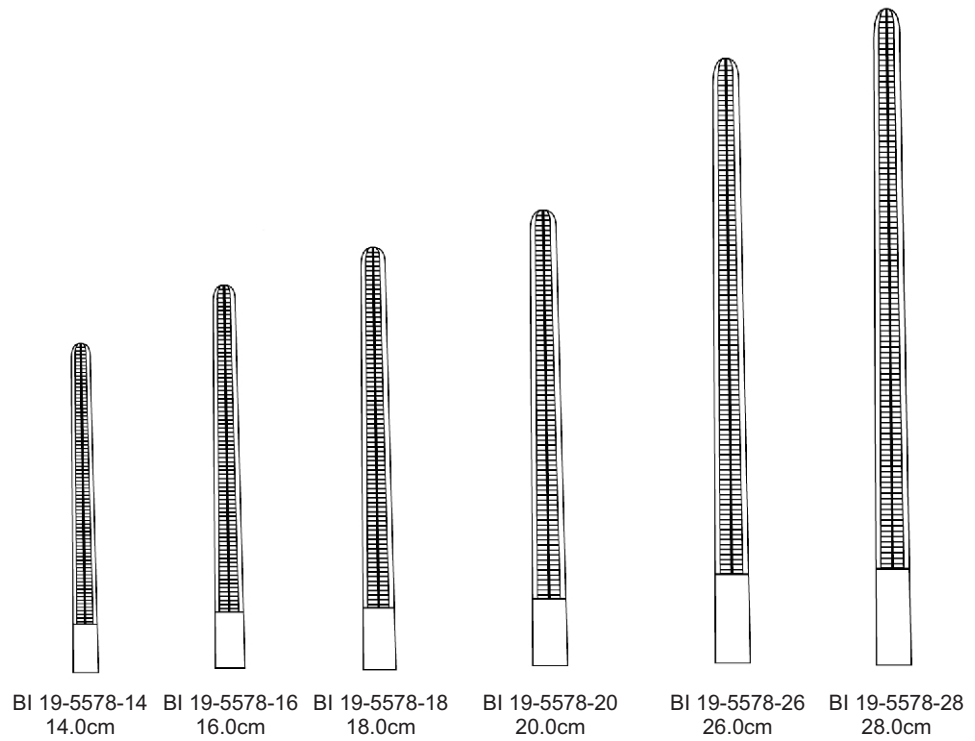



Aorta aneurysm clamps



De Bakey



De Bakey-Bahnson



BI 19-5579-23  
23 cm/9"



BI 19-5579-24  
24 cm/9½"



BI 19-5579-25  
25 cm/10"



DE BAKEY-PEAN

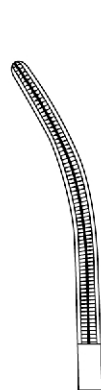

BI 19-5580-14  
14.0cm

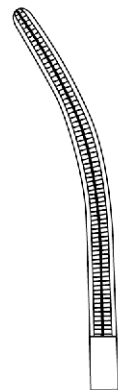

BI 19-5580-16  
16.0cm

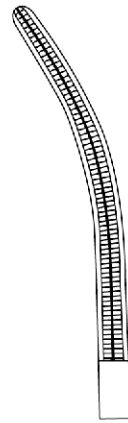

BI 19-5580-18  
18.0cm

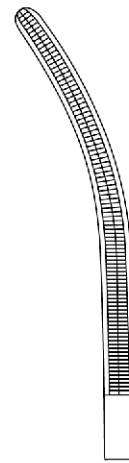

BI 19-5580-20  
20.0cm

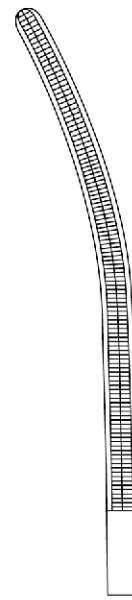

BI 19-5580-26  
26.0cm

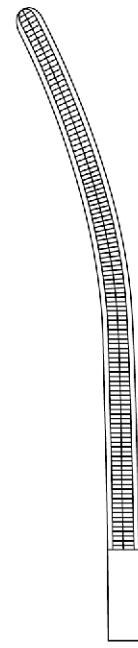

BI 19-5580-28  
28.0cm

Multi purpose clamps



De Bakey



**De Bakey-Rankin**



BI 19-5581-16  
16 cm/6¼"



BI 19-5582-16  
16 cm/6¼"



**Cooley**



BI 19-5583-16  
16 cm/6¼"

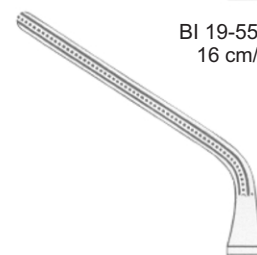

BI 19-5583-15  
15.5 cm/6"



BI 19-5583-14  
14.5 cm/5¾"



**De Bakey**  
 BI 19-5584-17  
 17 cm/6¾"

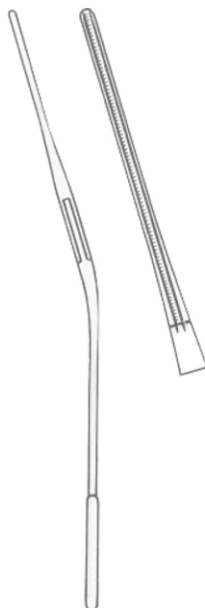

BI 19-5585-17

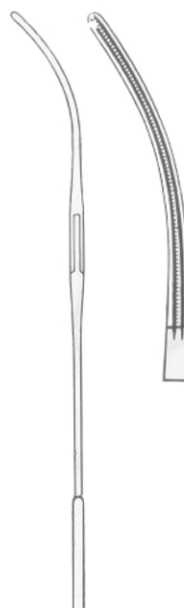

BI 19-5586-17

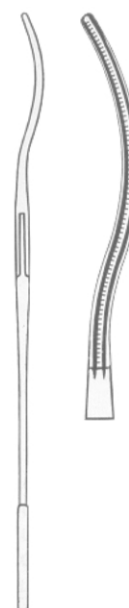

BI 19-5587-17



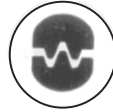

De Bakey

Ligature Clamps

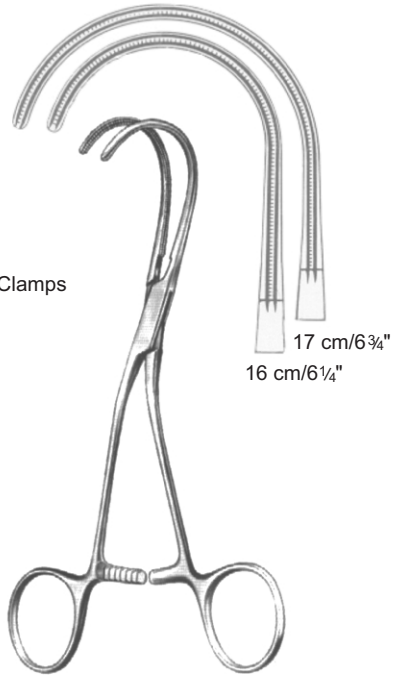

BI 19-5588-16 16cm/6¼"  
BI 19-5588-17 17cm/6¾"



Derra-De Bakey

BI 19-5589-16  
16.0 cm

BI 19-5589-17  
17.0 cm

BI 19-5589-18  
18.0 cm

Anastomosis Clamps

Profunda Clamps



Gregory

BI 19-5590-14  
14 cm/5½"

BI 19-5590-16  
16 cm/6¼"

BI 19-5590-18  
18 cm/7"



Cooley

Coarctation Clamps

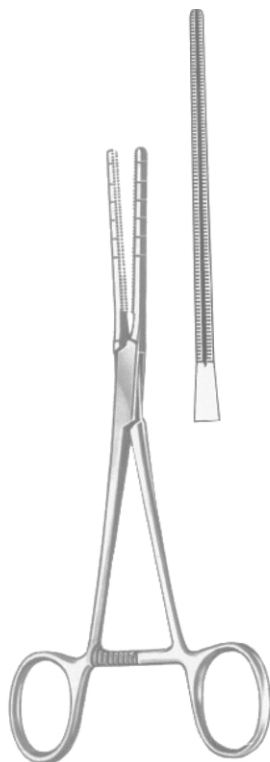

**Cooley**  
 BI 19-5591-17  
 17 cm/6¾"

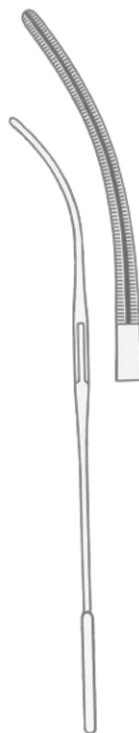

**Cooley**  
 BI 19-5592-17  
 17 cm/6¾"

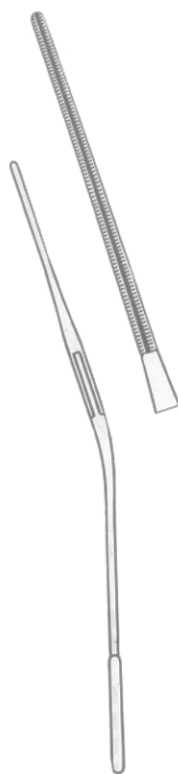

**Cooley**  
 BI 19-5593-17  
 17 cm/6¾"

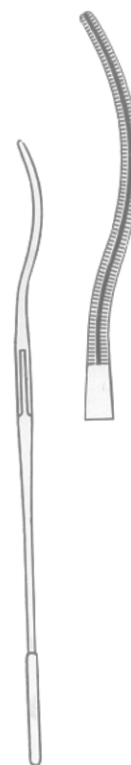

**Cooley**  
 BI 19-5594-17  
 17 cm/6¾"





**Cooley**  
BI 19-5595-20  
20 cm/8"



**Cooley**



**Cooley**



**Cooley**  
BI 19-5599-17  
17 cm/6 3/4"

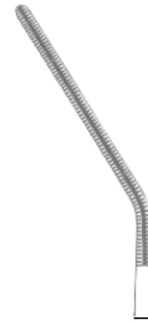

BI 19-5596-03  
17 cm/6 3/4"

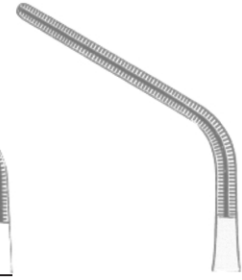

BI 19-5596-02  
15.5 cm/6"



BI 19-5596-01  
15 cm/6"



Anastomosis clamps



Cooley

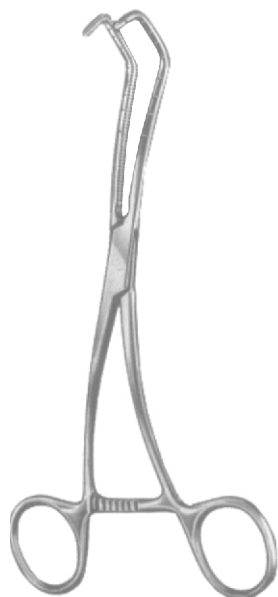

Cooley

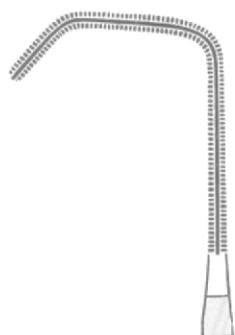

BI 19-5600-01  
 16.5 cm/6½"

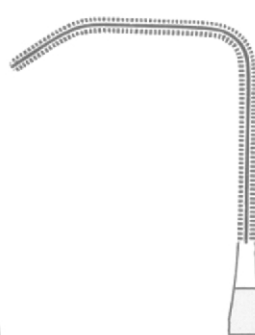

BI 19-5600-02  
 16.5 cm/6½"

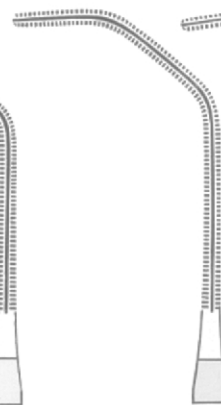

BI 19-5600-03  
 17.5 cm/7"

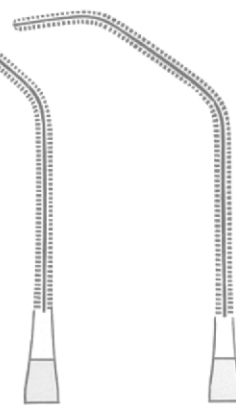

BI 19-5600-04  
 17.5 cm/7"

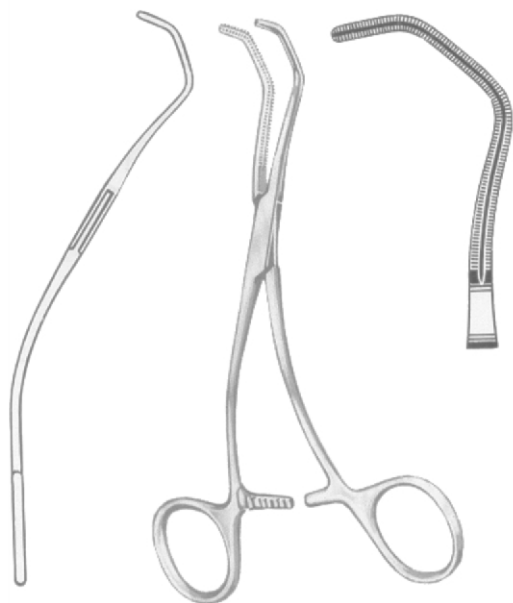

Cooley  
 BI 19-5601-16  
 16 cm/6¼"



Beck  
 BI 19-5602-17  
 17 cm/6¾"

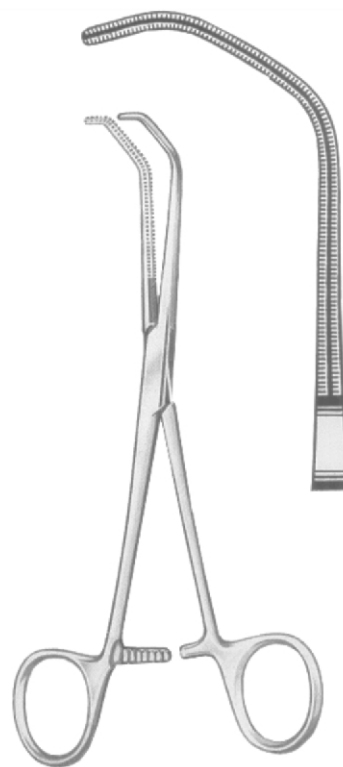



Cooley



Cooley-Derra

BI 19-5603-16  
16 cm/6 1/4"

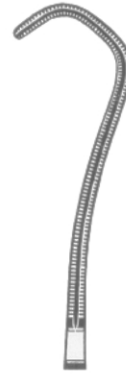

BI 19-5603-17  
17 cm/6 3/4"



BI 19-5603-18  
18 cm/7"



Cooley

BI 19-5604-16 16 cm/6 1/4"  
BI 19-5604-17 17 cm/6 3/4"

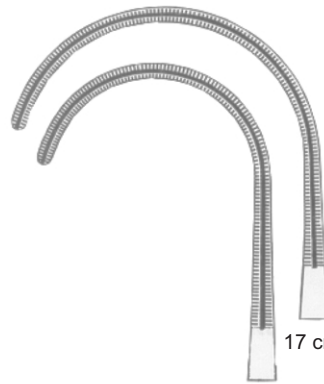

16 cm/6 1/4"

17 cm/6 3/4"

Ligature clamps



**Cooley**  
 14 cm/5½"

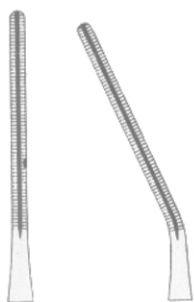

BI 19-5605-14 BI 19-5606-14

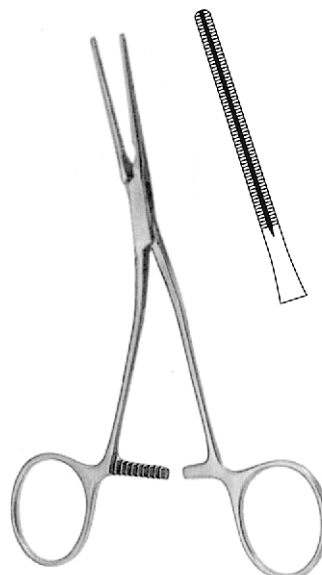

**Cooley**  
 BI 19-5607-14  
 14 cm/5½"



**Cooley**  
 BI 19-5608-14  
 14 cm/5½"



**Cooley**  
 BI 19-5609-14  
 14 cm/5½"



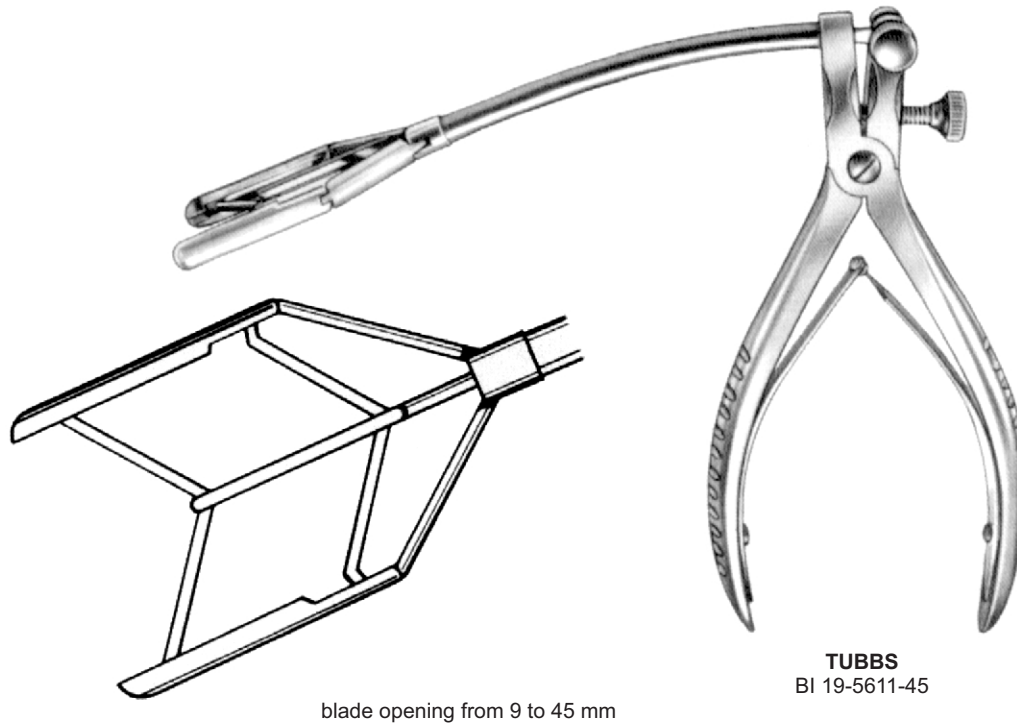
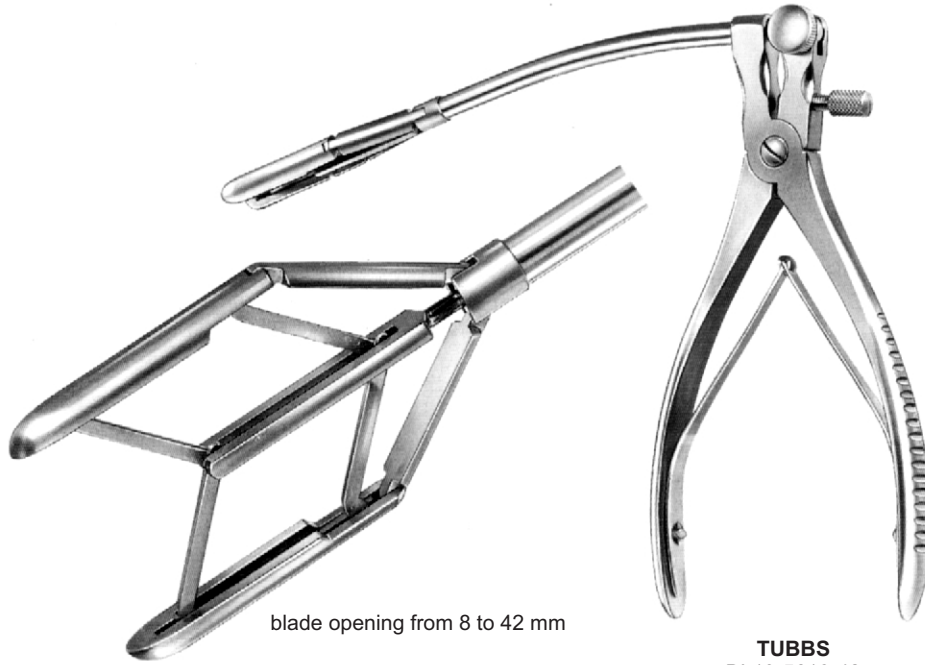

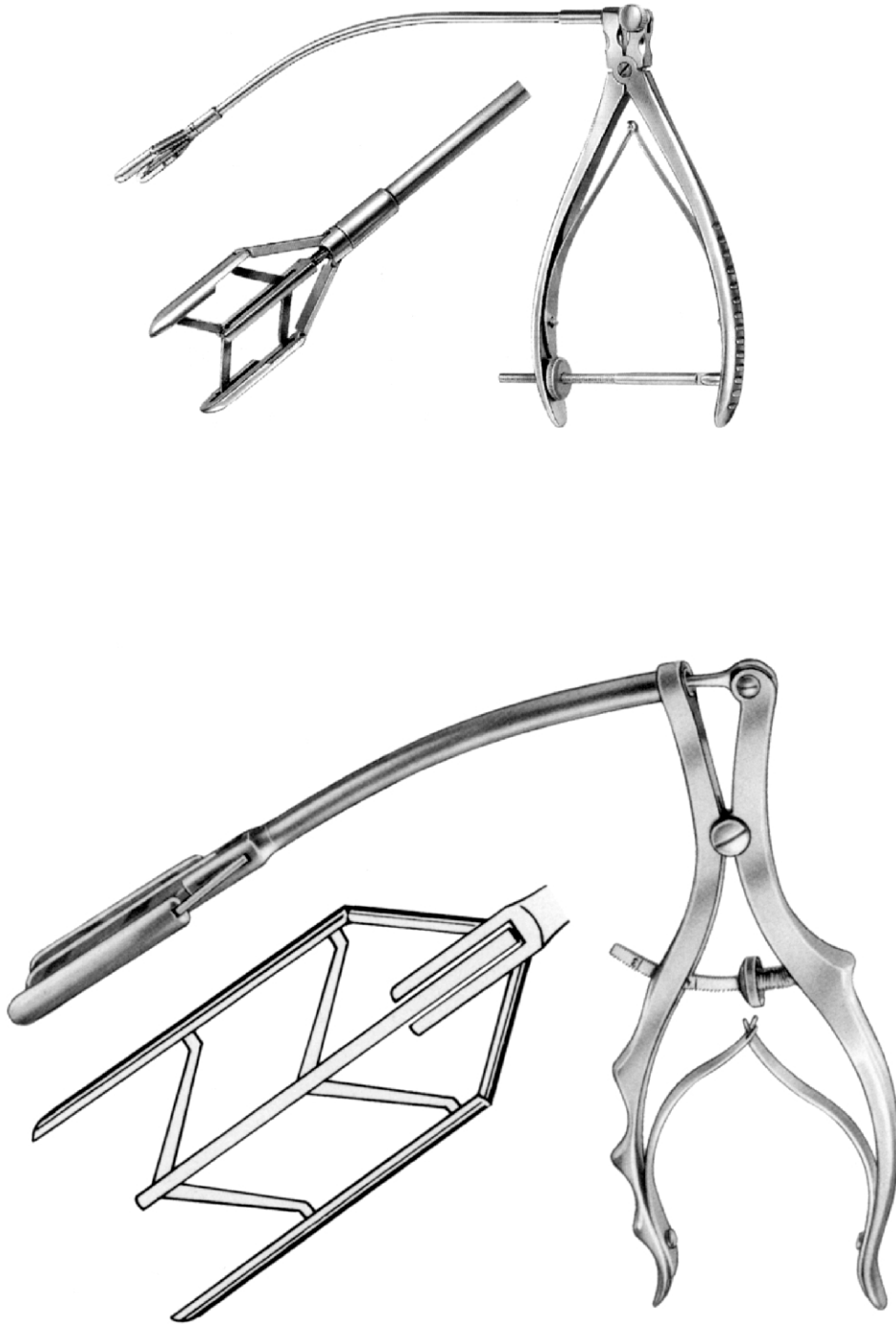

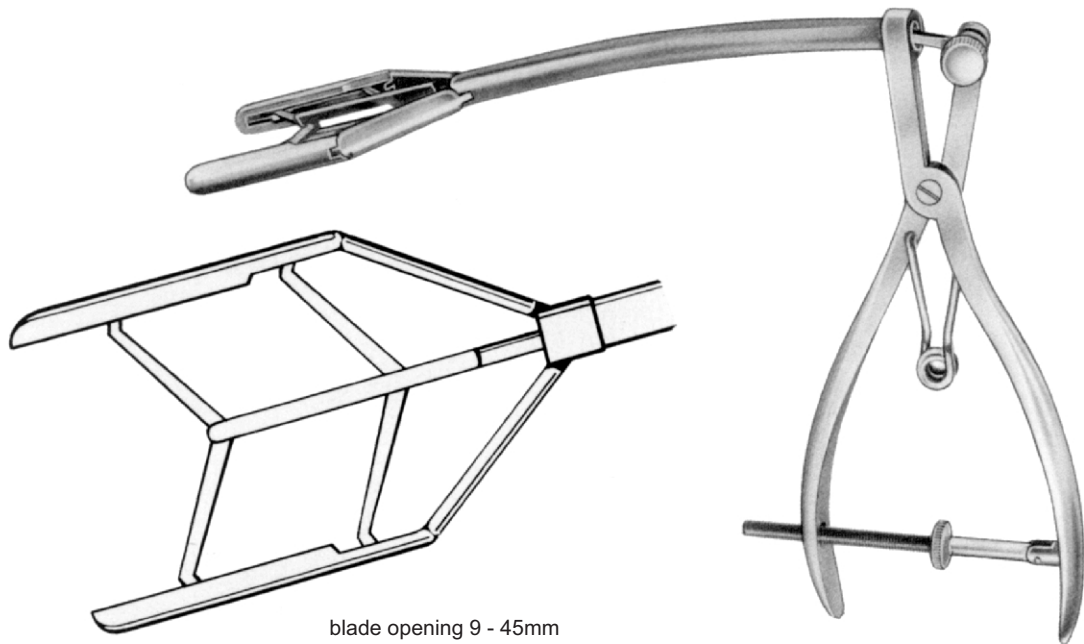

blade opening 9 - 45mm

**GERBODE**  
BI 19-5615-45

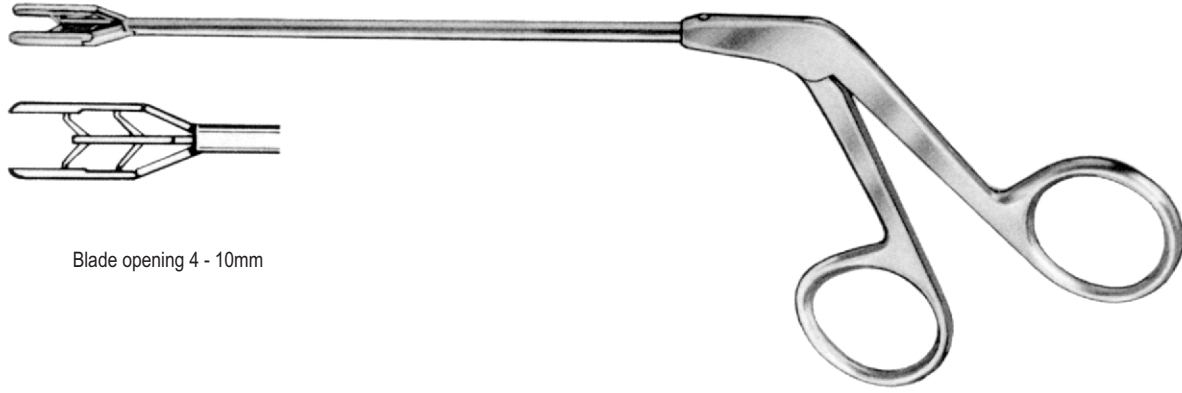

Blade opening 4 - 10mm

**HETZER**  
 BI 19-5616-10

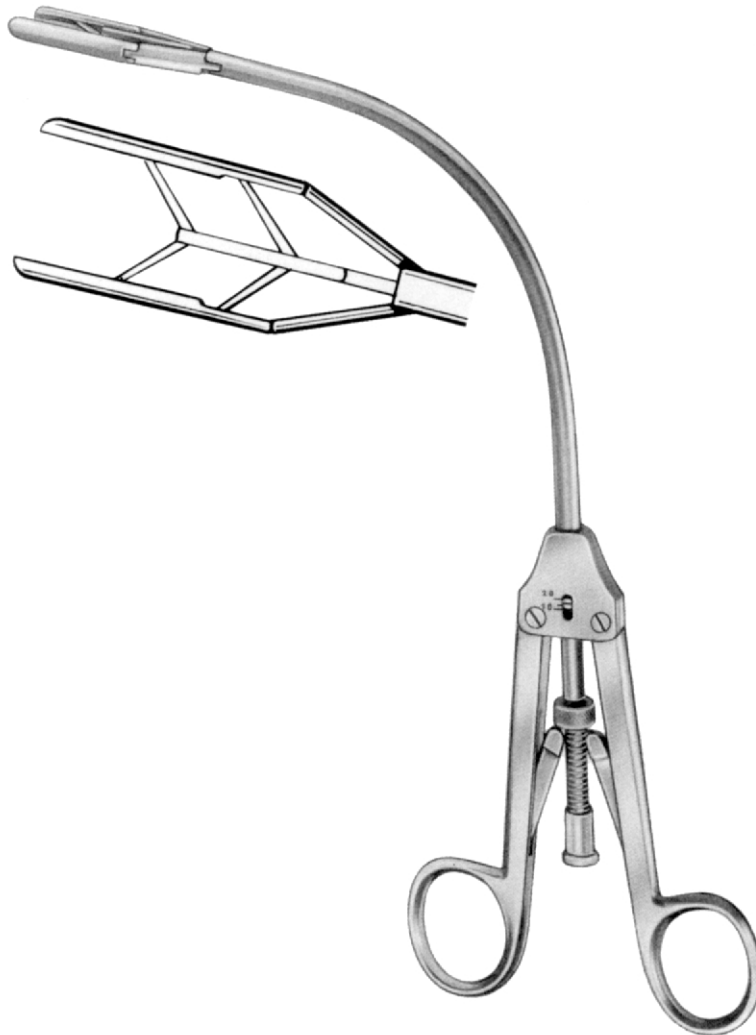

**COOLEY** blade opening  
 BI 19-5617-18 5 - 18mm  
 BI 19-5617-20 6 - 20mm





**DE BAKEY**

19.0cm  
35.0cm



BI 19-5619-05  
BI 19-5620-05  
0.5mm Ø



BI 19-5619-10  
BI 19-5620-10  
1mm Ø



BI 19-5619-15  
BI 19-5620-15  
1.5mm Ø



BI 19-5619-20  
BI 19-5620-20  
2mm Ø



BI 19-5619-25  
BI 19-5620-25  
2.5mm Ø



BI 19-5619-30  
BI 19-5620-30  
3mm Ø



19.0cm  
35.0cm

BI 19-5619-35  
BI 19-5620-35  
3.5mm Ø



BI 19-5619-40  
BI 19-5620-40  
4mm Ø



BI 19-5619-45  
BI 19-5620-45  
4.5mm Ø



BI 19-5619-50  
BI 19-5620-50  
5mm Ø



BI 19-5619-70  
BI 19-5620-70  
7mm Ø



BI 19-5619-90  
BI 19-5620-90  
9mm Ø

Malleable



**Cooley**  
13 cm/5"



BI 19-5621-05  
0.5 mm Ø



BI 19-5621-10  
1.0 mm Ø



BI 19-5621-15  
1.5 mm Ø



BI 19-5621-20  
2.0 mm Ø



BI 19-5621-25  
2.5 mm Ø



BI 19-5621-30  
3.0 mm Ø



BI 19-5621-40  
4.0 mm Ø



BI 19-5621-50  
5.0 mm Ø



CARDIOVASCULAR

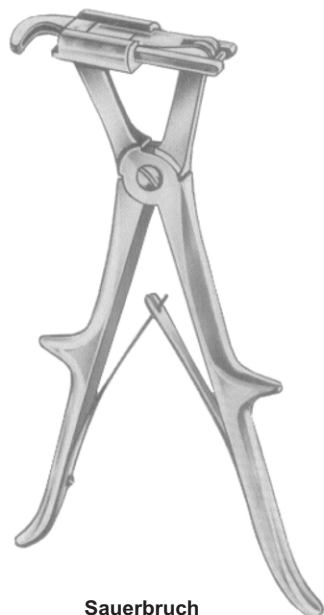

**Sauerbruch**  
 BI 19-5622-26  
 26 cm/10 1/4"



**Giertz-Stille**  
 BI 19-5623-27  
 27 cm/10 1/2"

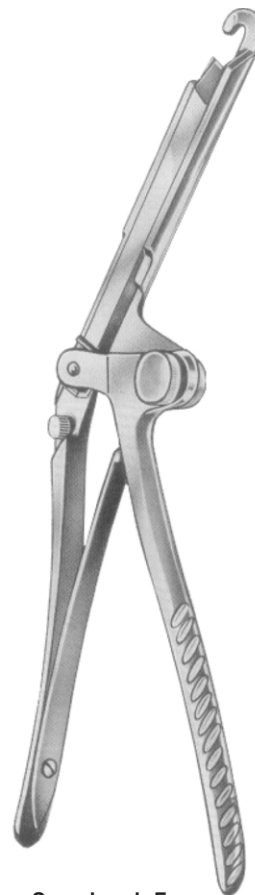

**Sauerbruch-Frey**  
 BI 19-5624-36  
 36 cm/14"



**Bethune**  
 BI 19-5625-34  
 34 cm/13 1/2"

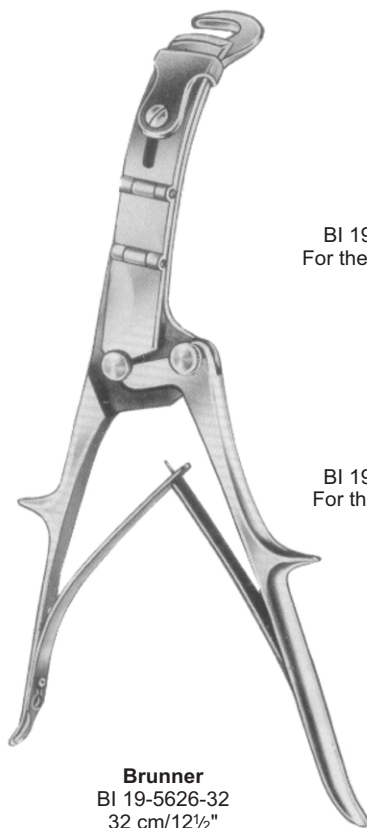

**Brunner**  
 BI 19-5626-32  
 32 cm/12 1/2"

BI 19-5626-32  
 For the Right Hand

BI 19-5627-32  
 For the left Hand



**Lebsche**  
 BI 19-5628-24  
 24.5 cm/9 3/4"





**CORYLLOS**  
BI 19-5629-35  
35.0cm

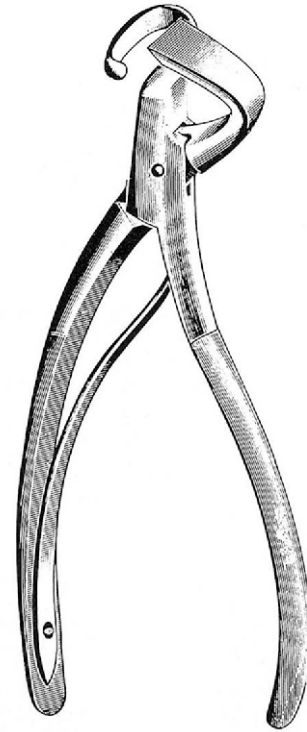

**DOYEN**  
BI 19-5630-19  
19.0cm

Bone and Rib Shears  
 Knochen-und Rippenscheren  
 Cizallas para huesos  
 Laryngoscopes de lumière et accessoires  
 Laringoscopi di luce fredda ed accessori

EN  
 DE  
 ES  
 FR  
 IT

**FAM BRO**<sup>®</sup>  
 NAME OF QUALITY INSTRUMENTS



**BETHUNE-NELSON**  
 BI 19-5631-34  
 34.0cm  
 with probe ended blades

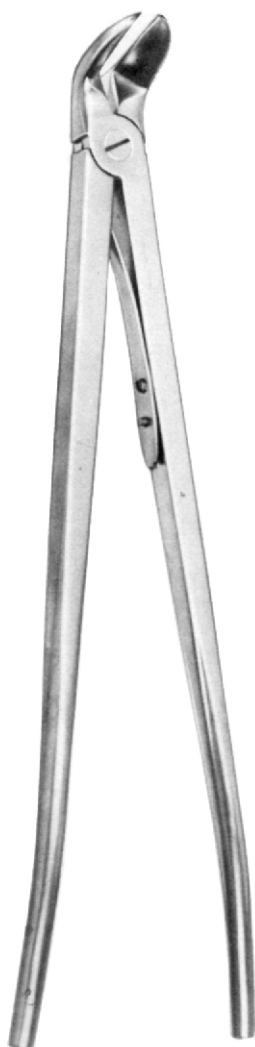

**ROBERTS**  
 BI 19-5632-34  
 34.0cm  
 with angular probe ended blades



**ROBERTS**  
 BI 19-5633-34  
 34.0cm  
 with angular probe ended  
 blades of first and second ribs





**SCHUMACHER**  
BI 19-5634-20  
20.0cm



**TUDOR EDWARDS**  
BI 19-5635-23  
23.0cm

Bone and Rib Shears ● EN  
Knochen-und Rippenscheren ● DE  
Cizallas para huesos ● ES  
Laryngoscopes de lumière et accessoires ● FR  
Laringoscopi di luce fredda ed accessori ● IT



**LEBSCHE**  
BI 19-5636-25  
25.0cm





**CASTAÑEDA**

S/S

ALU

BI 19-5637-01

BI 19-5637-11

a  
10.5mm

b  
32mm

c  
65mm

BI 19-5637-02

BI 19-5637-12

16mm

30mm

65mm

Scheme of dimensions

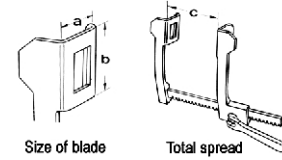

Size of blade

Total spread



**CASTAÑEDA**

S/S

ALU

BI 19-5638-01

BI 19-5638-11

a  
12mm

b  
45mm

c  
70mm



**CASTAÑEDA**

S/S

ALU

BI 19-5639-01

BI 19-5639-11

a  
15mm

b  
60mm

c  
120mm

Rib Spreaders ● EN  
 Rippensperrer ● DE  
 Separadores costales ● ES  
 LaÉpandeurs de côtes ● FR  
 Spalmatori di costole ● IT

**COOLEY**

S/S	ALU	a	b	c
BI 19-5640-01	BI 19-5640-11	12mm	16mm	95mm
BI 19-5640-02	BI 19-5640-12	12mm	17mm	75mm
BI 19-5640-03	BI 19-5640-13	14mm	16mm	85mm

**COOLEY**

S/S	ALU	a	b	c
BI 19-5641-01	BI 19-5641-11	15mm	30mm	115mm
BI 19-5641-02	BI 19-5641-12	15mm	30mm	140mm
BI 19-5641-03	BI 19-5641-13	16mm	30mm	105mm
BI 19-5641-04	BI 19-5641-14	20mm	45mm	140mm
BI 19-5641-05	BI 19-5641-15	21mm	44mm	150mm
BI 19-5641-06	BI 19-5641-16	30mm	35mm	140mm

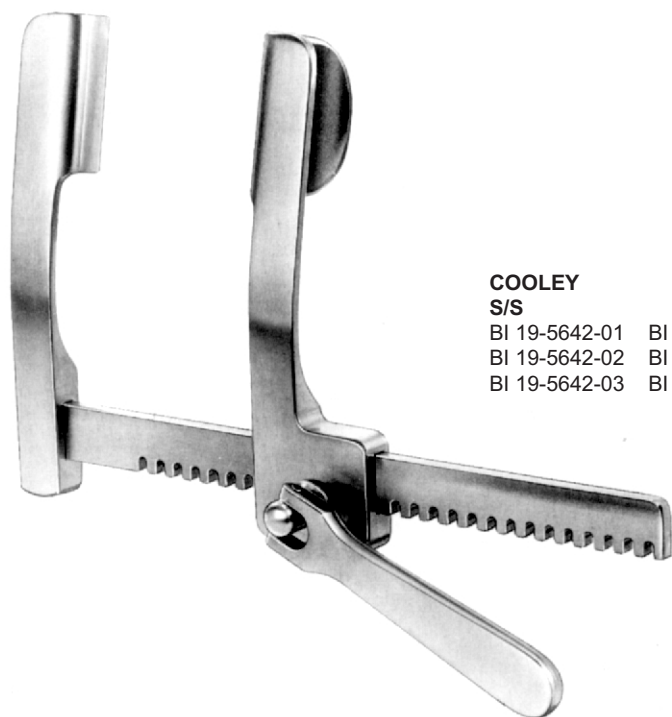
**COOLEY**

S/S	ALU	a	b	c
BI 19-5642-01	BI 19-5642-11	30mm	50mm	185mm
BI 19-5642-02	BI 19-5642-12	35mm	50mm	200mm
BI 19-5642-03	BI 19-5642-13	37mm	49mm	200mm





**COOLEY**  
for neonatal

<b>S/S</b>	<b>ALU</b>	<b>a</b>	<b>b</b>	<b>c</b>
BI 19-5643-01	BI 19-5643-11	12mm	15mm	70mm

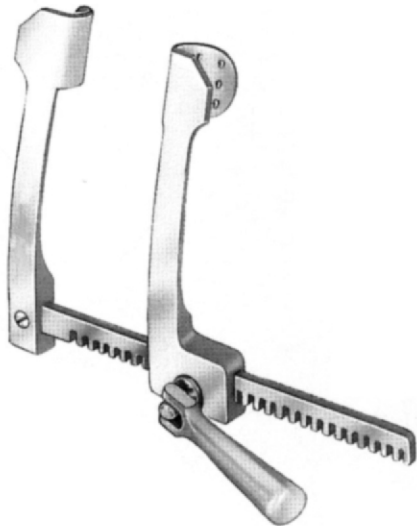

**COOLEY**  
infant, sternal spreader

<b>S/S</b>	<b>ALU</b>	<b>a</b>	<b>b</b>	<b>c</b>
BI 19-5644-01	BI 19-5644-11	15mm	20mm	100mm



**COOLEY**  
for babies

<b>S/S</b>	<b>ALU</b>	<b>a</b>	<b>b</b>	<b>c</b>
BI 19-5645-01	BI 19-5646-01	20mm	25mm	80mm



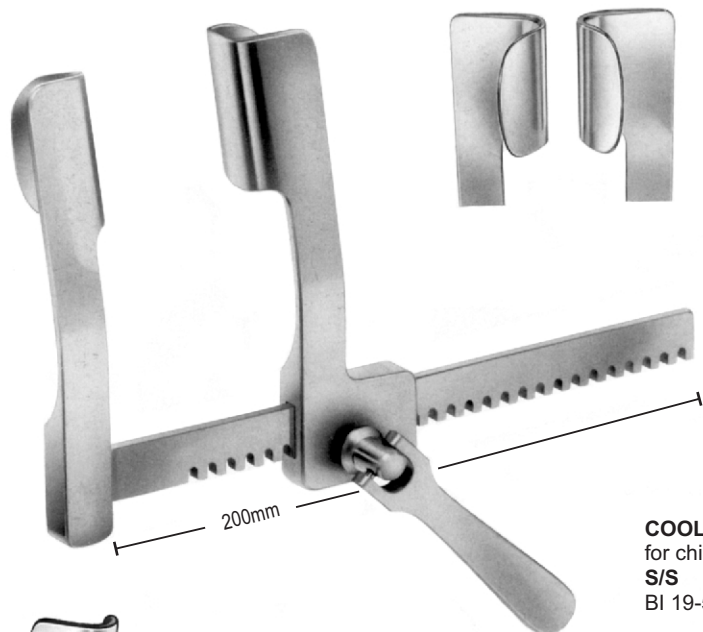

**COOLEY**  
 for children  
**S/S** **ALU** **a** **b** **c**  
 BI 19-5647-01 BI 19-5648-01 21mm 45mm 145mm  
 for adult  
 BI 19-5647-02 BI 19-5648-02 32mm 50mm 190mm

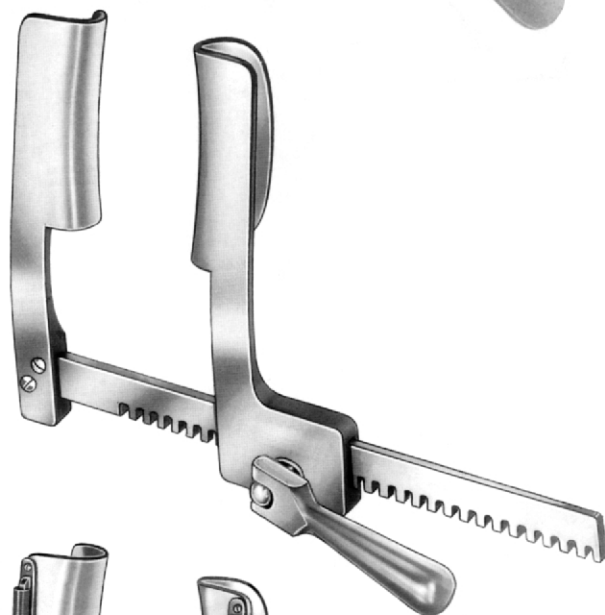

**COOLEY**  
 for children  
**S/S** **ALU** **a** **b** **c**  
 BI 19-5649-01 BI 19-5650-01 35mm 100mm 180mm  
 for adult  
 BI 19-5649-02 BI 19-5650-02 35mm 115mm 230mm



**COOLEY**  
 for adults with suture separator  
**S/S** **ALU** **a** **b** **c**  
 BI 19-5651-01 BI 19-5652-01 35mm 100mm 180mm





**H-COOLEY**  
with swivel convex blades, for babies  
**S/S** **ALU** **a** **b** **c**  
BI 19-5653-01 BI 19-5654-01 10mm 15mm 90mm



**H-COOLEY**  
with swivel blades, for babies  
**S/S** **ALU** **a** **b** **c**  
BI 19-5655-02 BI 19-5656-02 10mm 15mm 90mm

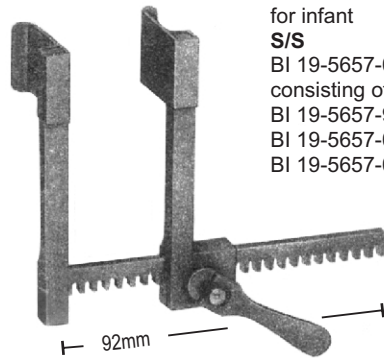

**STRUCK**  
for infant  
**S/S** **ALU**  
BI 19-5657-00 BI 19-5657-01  
consisting of  
BI 19-5657-90 spreader only  
BI 19-5657-04 1 pair  
BI 19-5657-05 1 pair

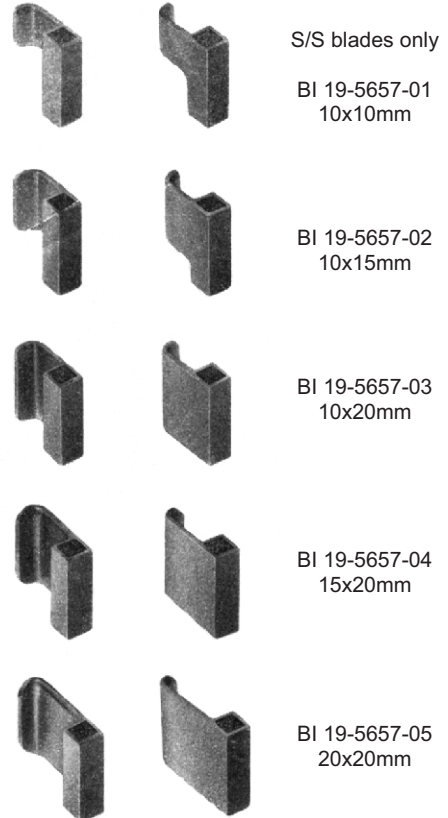

S/S blades only

BI 19-5657-01  
10x10mm

BI 19-5657-02  
10x15mm

BI 19-5657-03  
10x20mm

BI 19-5657-04  
15x20mm

BI 19-5657-05  
20x20mm

Rib Spreaders ● EN  
 Rippensperrer ● DE  
 Separadores costales ● ES  
 LaÉpandeurs de côtes ● FR  
 Spalmatori di costole ● IT



**WEINBERG**  
for children

S/S	ALU	a	b	c
BI 19-5658-01	BI 19-5659-01	12mm	20mm	95mm

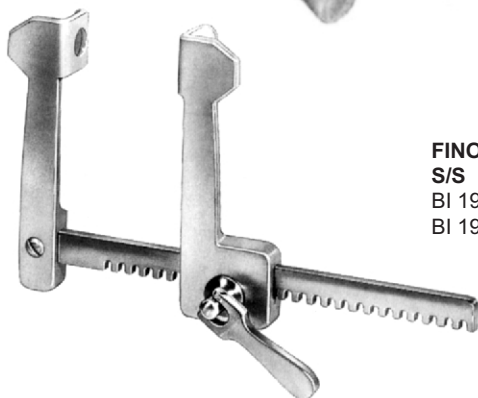

**FINOCHIETTO-INFANT**

S/S	ALU	a	b	c
BI 19-5660-01	BI 19-5661-01	12mm	15mm	70mm
BI 19-5660-02	BI 19-5661-02	15mm	15mm	75mm

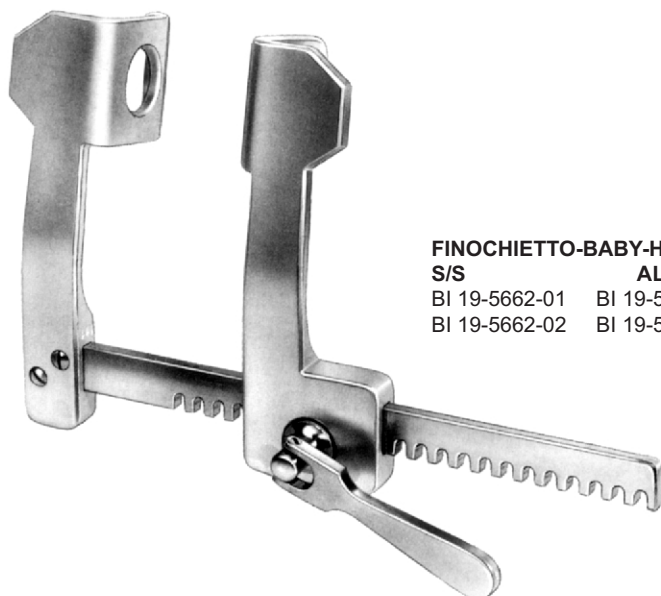

**FINOCHIETTO-BABY-HAIGHT**

S/S	ALU	a	b	c
BI 19-5662-01	BI 19-5663-01	27mm	30mm	95mm
BI 19-5662-02	BI 19-5663-02	31mm	31mm	100mm



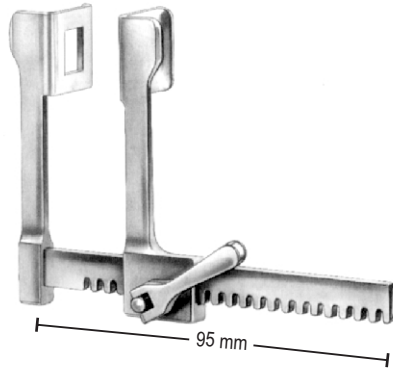

**FINOCHIETTO-BABY**

S/S	ALU	a	b	c
BI 19-5664-01	BI 19-5665-01	14mm	15mm	75mm
BI 19-5664-02	BI 19-5665-02	18mm	20mm	75mm

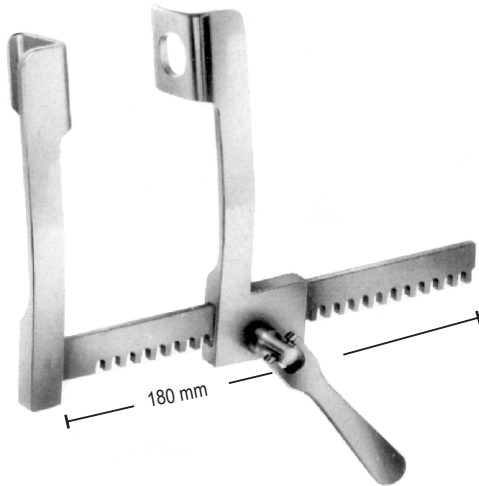

S/S	ALU	a	b	c
BI 19-5666-01	BI 19-5667-01	28mm	32mm	120mm



**FINOCHIETTO**

S/S	ALU	a	b	c
BI 19-5668-01	BI 19-5669-01	12mm	15mm	100mm
BI 19-5668-02	BI 19-5669-02	28mm	30mm	143mm
BI 19-5668-03	BI 19-5669-03	31mm	45mm	210mm
BI 19-5668-04	BI 19-5669-04	42mm	61mm	245mm
BI 19-5668-05	BI 19-5669-05	74mm	64mm	245mm

Rib Spreaders ● EN  
 Rippensperrer ● DE  
 Separadores costales ● ES  
 LaÉpandeurs de côtes ● FR  
 Spalmatori di costole ● IT

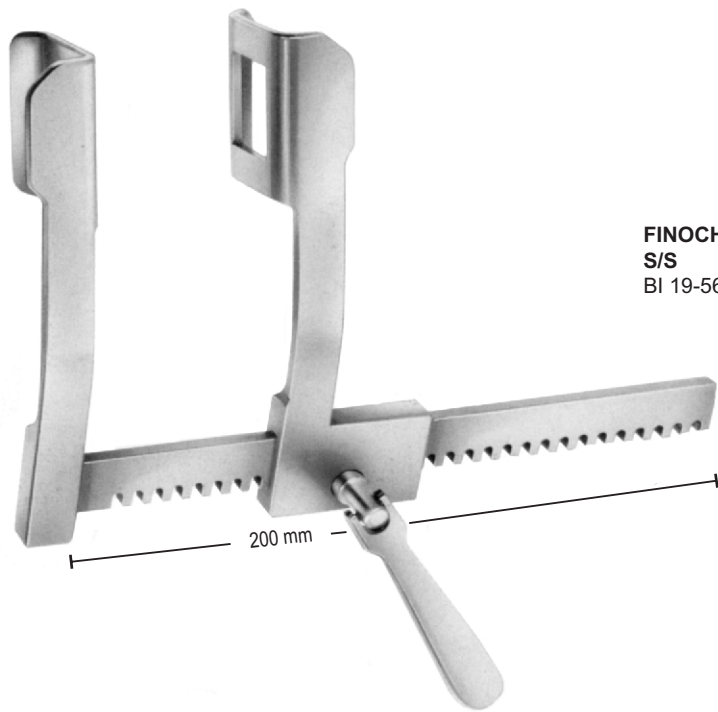
**FINOCHIETTO****S/S****ALU****a****b****c**

BI 19-5670-01

BI 19-5671-01

36mm

45mm

140mm

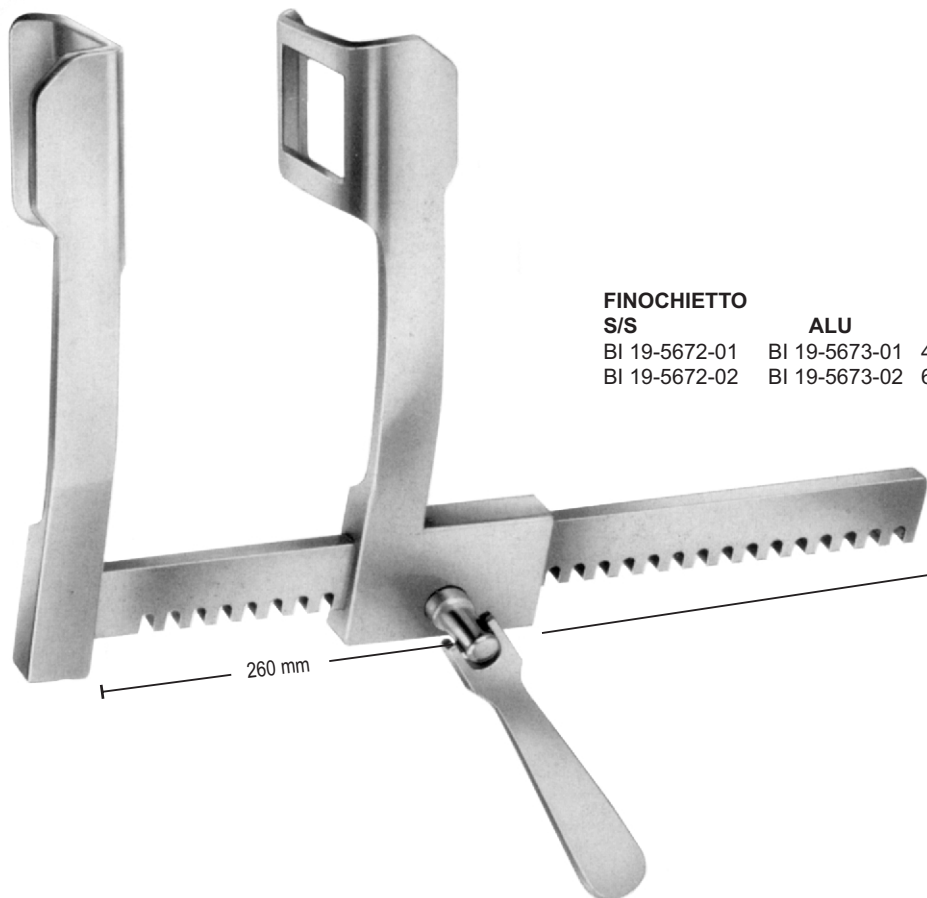
**FINOCHIETTO****S/S****ALU****a****b****c**

BI 19-5672-01

BI 19-5673-01

44mm

65mm

210mm

BI 19-5672-02

BI 19-5673-02

65mm

65mm

210mm



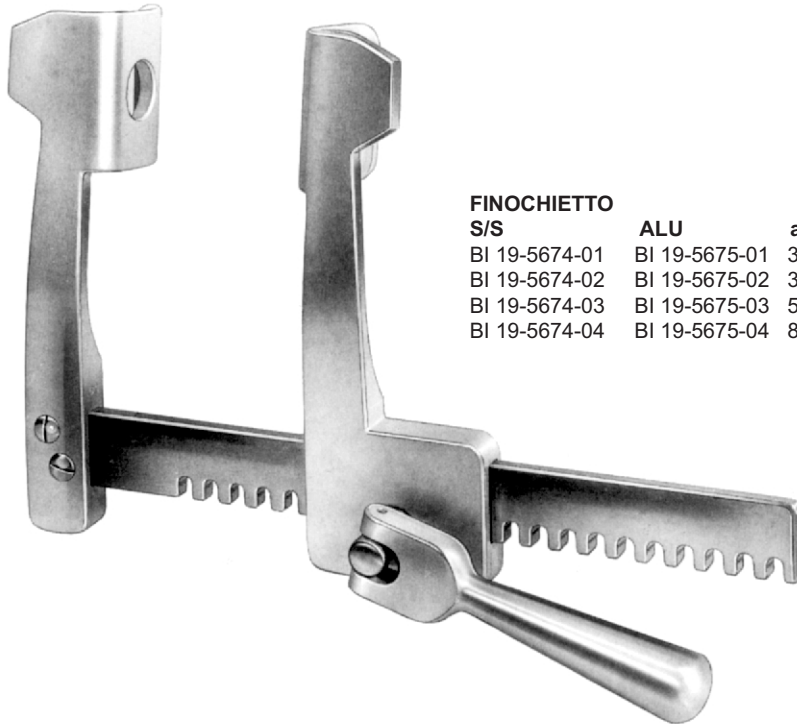

**FINOCHIETTO  
S/S**

	ALU	a	b	c
BI 19-5674-01	BI 19-5675-01	30mm	45mm	140mm
BI 19-5674-02	BI 19-5675-02	38mm	44mm	135mm
BI 19-5674-03	BI 19-5675-03	52mm	62mm	175mm
BI 19-5674-04	BI 19-5675-04	85mm	85mm	175mm

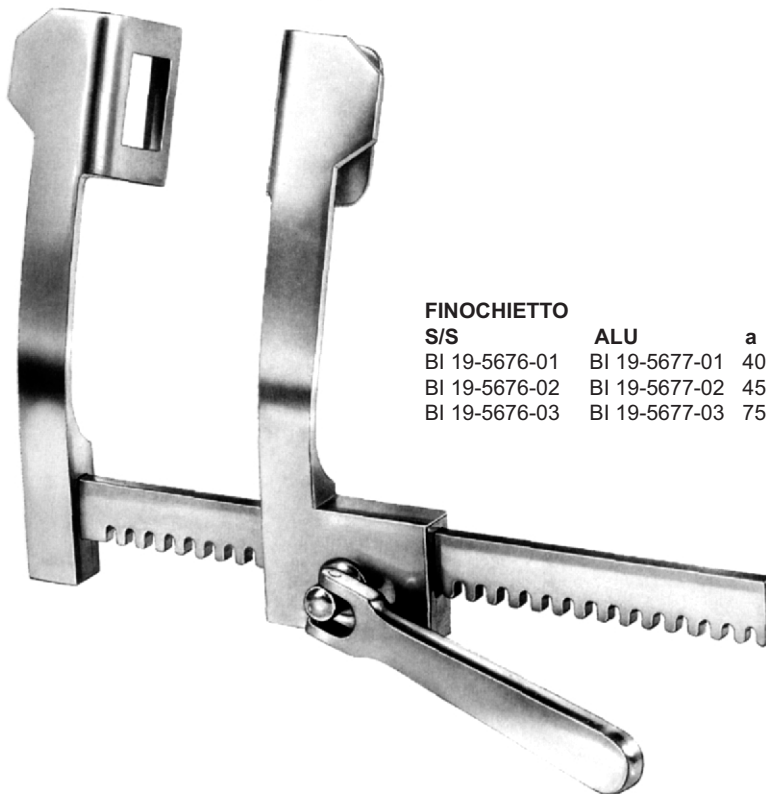

**FINOCHIETTO  
ALU**

	ALU	a	b	c
BI 19-5676-01	BI 19-5677-01	40mm	40mm	165mm
BI 19-5676-02	BI 19-5677-02	45mm	65mm	200mm
BI 19-5676-03	BI 19-5677-03	75mm	65mm	250mm

Rib Spreaders — EN  
 Rippensperrer — DE  
 Separadores costales — ES  
 LaÉpandeurs de côtes — FR  
 Spalmatori di costole — IT

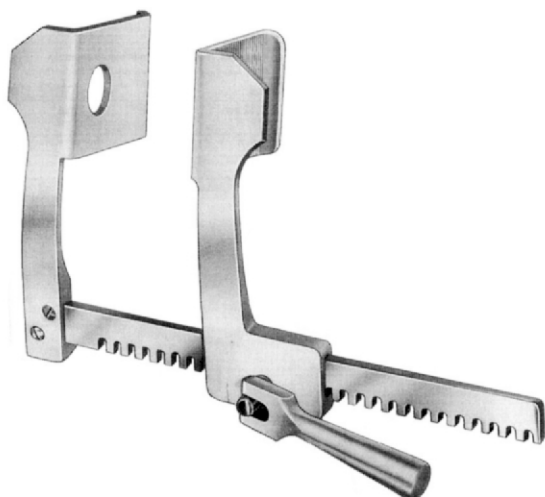
**FINOCHIETTO**

for adults

S/S	ALU	a	b	c
BI 19-5678-01	BI 19-5679-01	52mm	62mm	175mm
BI 19-5678-02	BI 19-5679-02	85mm	65mm	175mm

**FINOCHIETTO**

for adults, with suture separator

S/S	ALU	a	b	c
BI 19-5680-01	BI 19-5681-01	85mm	65mm	175mm

**FINOCHIETTO**

for adults, with 2 blades attached to each arm

S/S	ALU	a	b	c
BI 19-5682-01	BI 19-5683-01	10mm	15mm	120mm
BI 19-5682-02	BI 19-5683-02	14mm	14mm	120mm
BI 19-5682-03	BI 19-5683-03	14mm	20mm	120mm



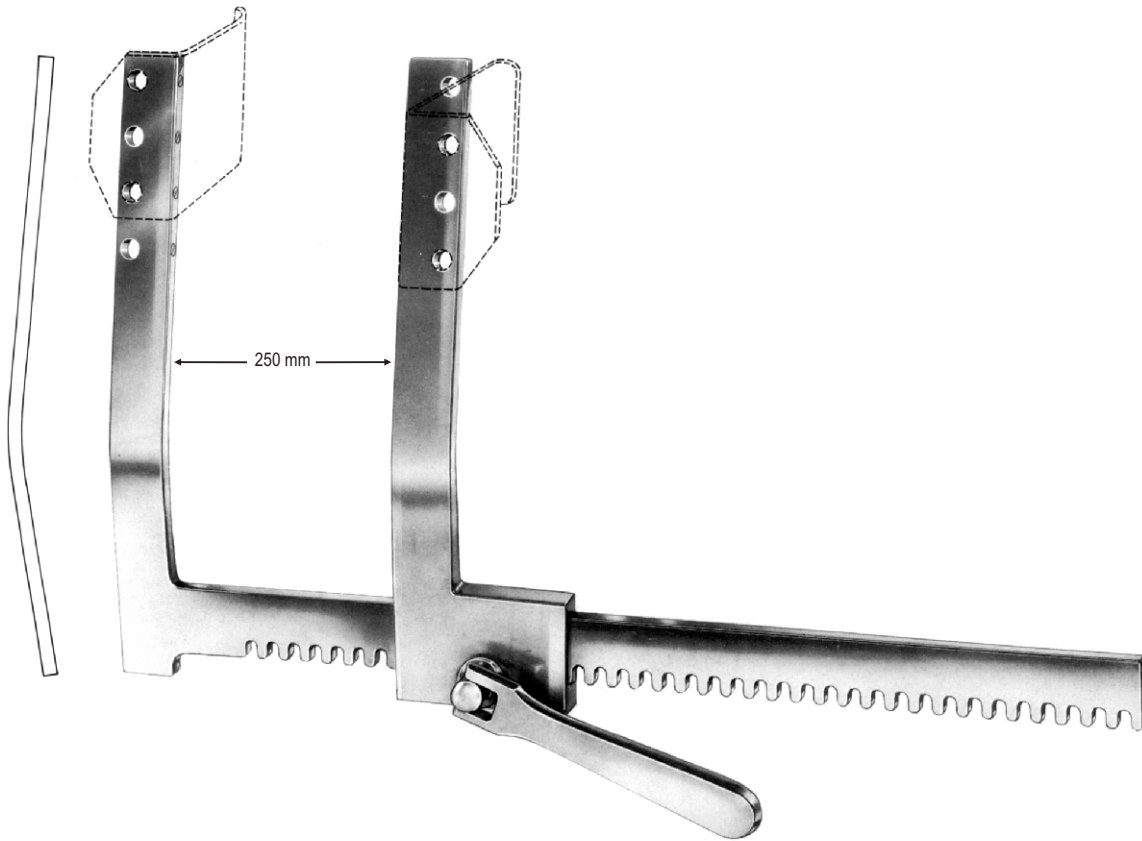

**FINOCHIETTO**

3 pairs of exchangeable blades

S/S	ALU	S/S	ALU
BI 19-5684-00	BI 19-5685-00	BI 19-5686-00	BI 19-5687-00
blades		blades	
BI 19-5684-30	BI 19-5685-30	BI 19-5686-40	BI 19-5687-40
BI 19-5684-40	BI 19-5685-40	BI 19-5686-50	BI 19-5687-50
BI 19-5684-50	BI 19-5685-50	BI 19-5686-60	BI 19-5687-60
frame only 150mm		frame only 250mm	
BI 19-5684-01	BI 19-5685-01	BI 19-5686-01	BI 19-5687-01



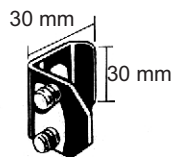

S/S      Alu  
 BI 19-5684-30 BI 19-5685-30  
 30x30mm

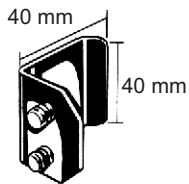

S/S      Alu  
 BI 19-5684-40 BI 19-5685-40  
 40x40mm

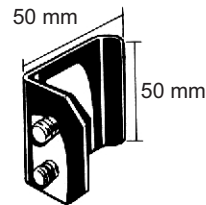

S/S      Alu  
 BI 19-5684-50 BI 19-5685-50  
 50x50mm

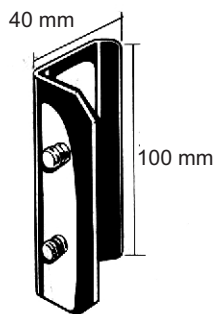

S/S      Alu  
 BI 19-5686-40 BI 19-5687-40  
 40x100mm

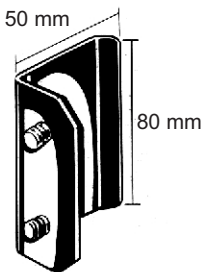

S/S      Alu  
 BI 19-5686-50 BI 19-5687-50  
 50x80mm

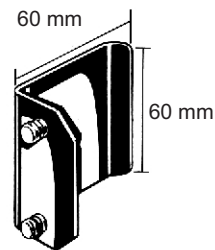

S/S      Alu  
 BI 19-5686-60 BI 19-5687-60  
 60x60mm

Optional Exchangeable Blades

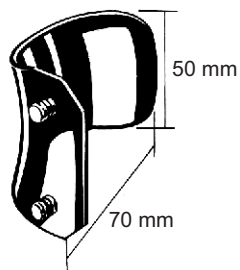

S/S      Alu  
 BI 19-5686-70 BI 19-5687-70  
 70x50mm

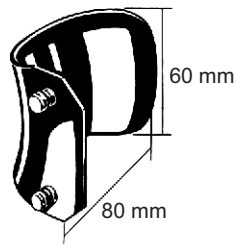

S/S      Alu  
 BI 19-5686-80 BI 19-5687-80  
 80x60mm

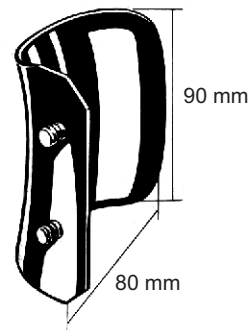

S/S      Alu  
 BI 19-5686-90 BI 19-5687-90  
 80x90mm





**BURFORD**  
for children  
with 2 pairs of blades

S/S	ALU	a	b	c
BI 19-5688-01	BI 19-5689-01	30mm	42mm	130mm
BI 19-5688-02	BI 19-5689-02	41mm	42mm	135mm
		34mm	42mm	135mm
		48mm	42mm	



**BURFORD**  
for adults  
with 2 pairs of blades

S/S	ALU	a	b	c
BI 19-5690-01	BI 19-5691-01	47mm	62mm	200mm
		65mm	62mm	
BI 19-5690-02	BI 19-5691-02	47mm	62mm	260mm
		65mm	62mm	
BI 19-5690-03	BI 19-5691-03	47mm	62mm	300mm
		65mm	62mm	

Rib Spreaders — EN  
 Rippensperrer — DE  
 Separadores costales — ES  
 LaÉpandeurs de côtes — FR  
 Spalmatori di costole — IT

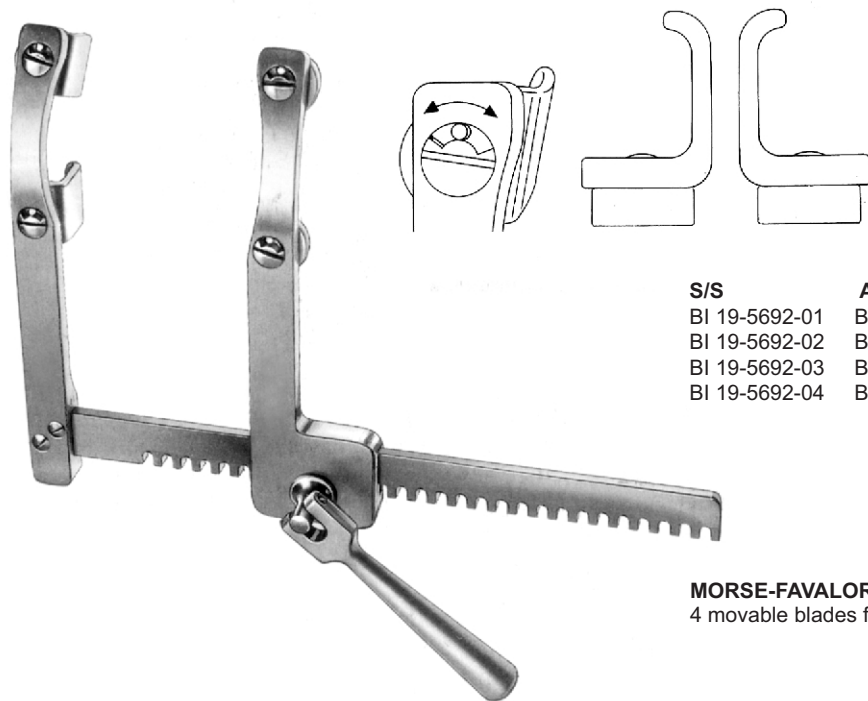

S/S	ALU	a	b	c
BI 19-5692-01	BI 19-5693-01	12mm	20mm	155mm
BI 19-5692-02	BI 19-5693-02	20mm	20mm	155mm
BI 19-5692-03	BI 19-5693-03	40mm	20mm	155mm
BI 19-5692-04	BI 19-5693-04	17mm	22mm	160mm

**MORSE-FAVALORO**  
 4 movable blades for children

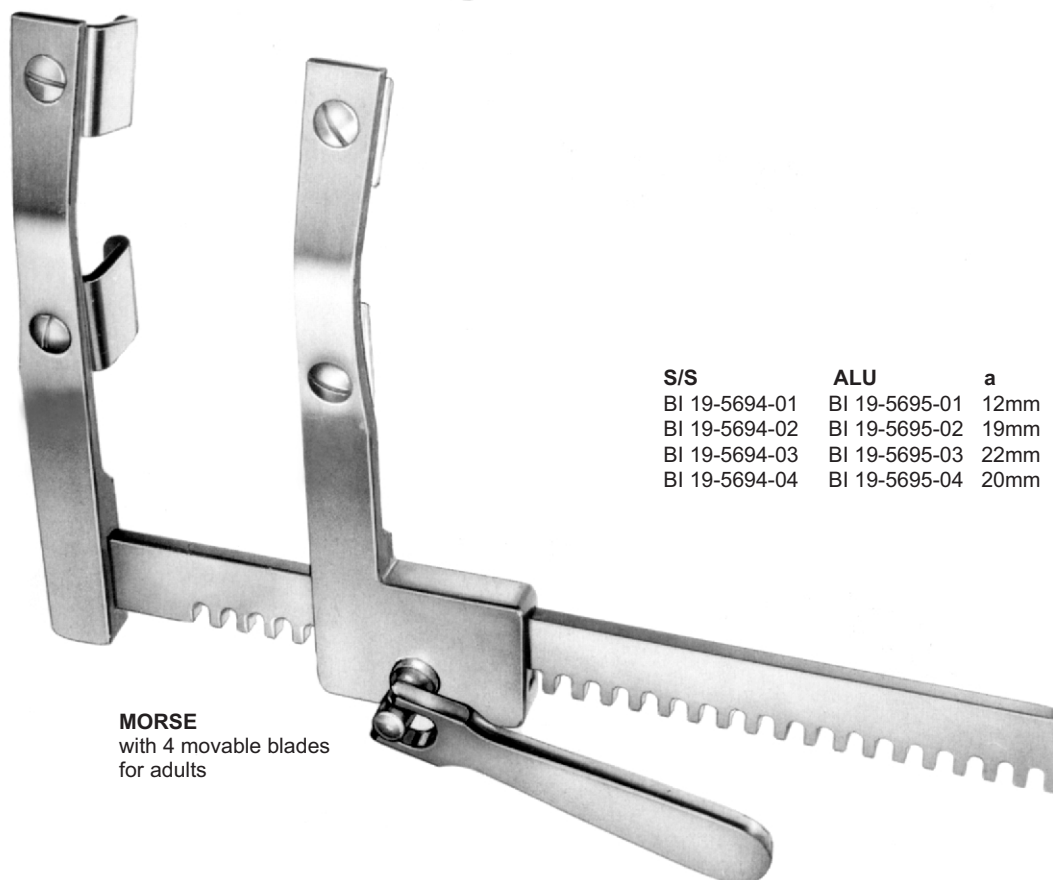

S/S	ALU	a	b	c
BI 19-5694-01	BI 19-5695-01	12mm	20mm	200mm
BI 19-5694-02	BI 19-5695-02	19mm	19mm	200mm
BI 19-5694-03	BI 19-5695-03	22mm	27mm	200mm
BI 19-5694-04	BI 19-5695-04	20mm	28mm	210mm

**MORSE**  
 with 4 movable blades  
 for adults



**MORSE STERNAL**

S/S	ALU	a	b	c
BI 19-5696-01	BI 19-5697-01	30mm	35mm	200mm

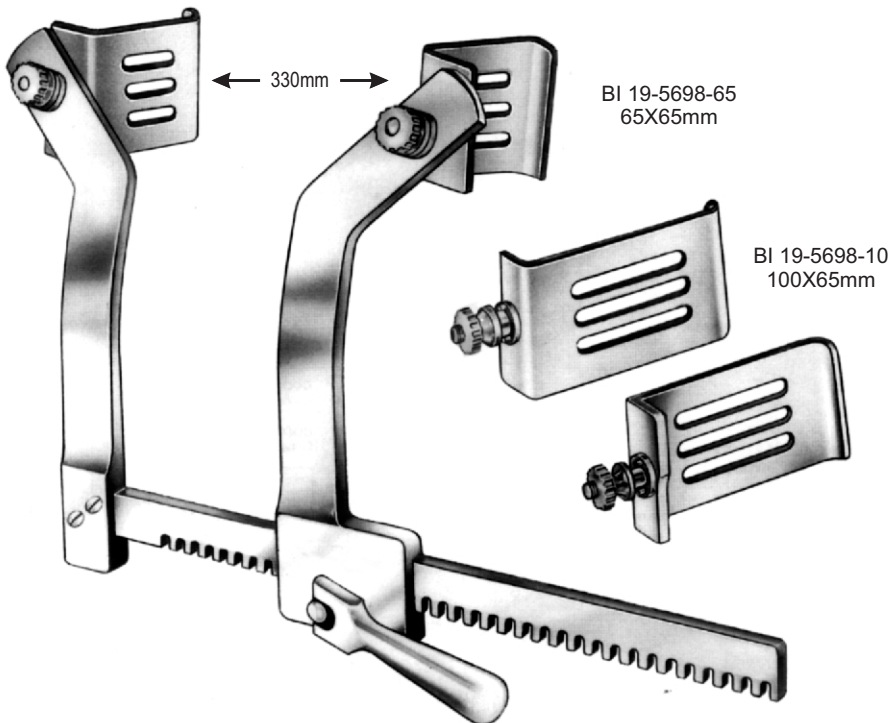

**BRAASTAD**

S/S	ALU
BI 19-5698-01	BI 19-5699-.01
with 2 pairs of blades	
BI 19-5698-65	BI 19-5699-65
BI 19-5698-10	BI 19-5699-10

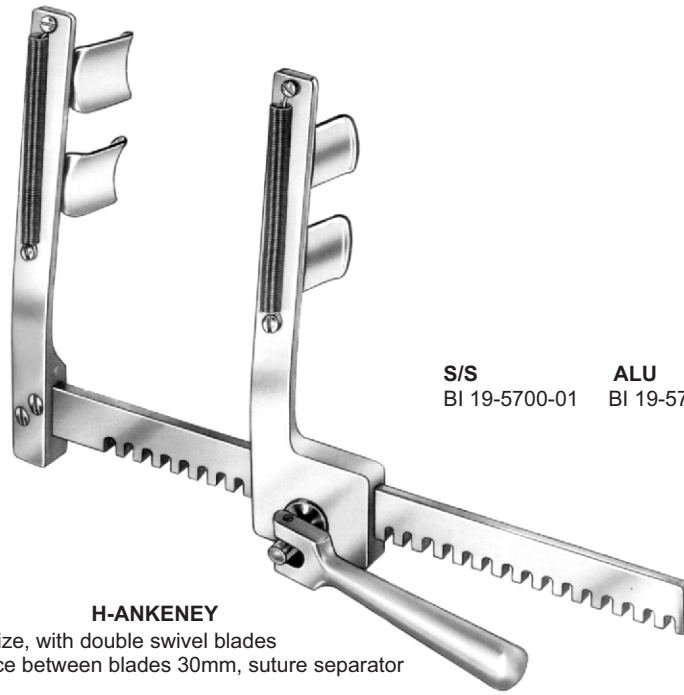

<b>S/S</b>	<b>ALU</b>	<b>a</b>	<b>b</b>	<b>c</b>
BI 19-5700-01	BI 19-5700-11	20mm	20mm	160mm

**H-ANKENEY**  
 child size, with double swivel blades  
 distance between blades 30mm, suture separator

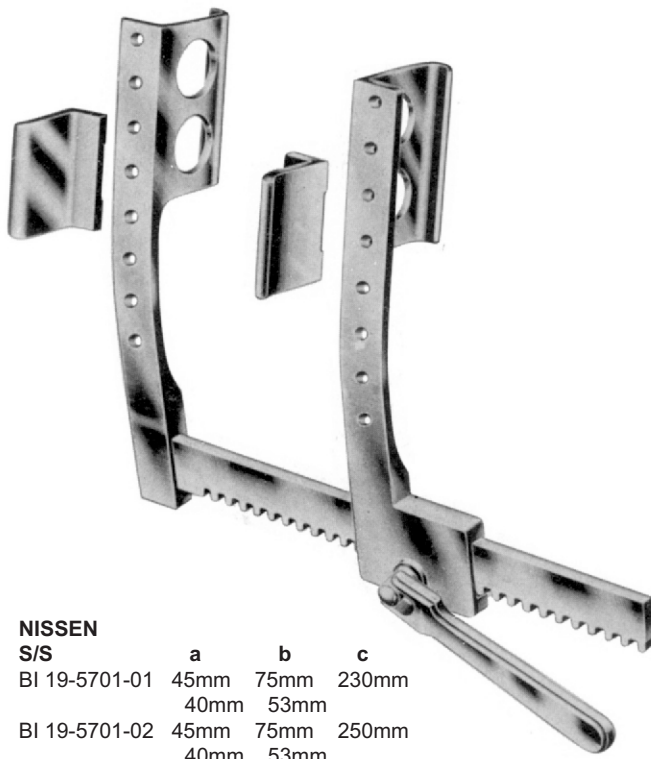

<b>NISSEN</b>	<b>a</b>	<b>b</b>	<b>c</b>
<b>S/S</b>			
BI 19-5701-01	45mm	75mm	230mm
	40mm	53mm	
BI 19-5701-02	45mm	75mm	250mm
	40mm	53mm	

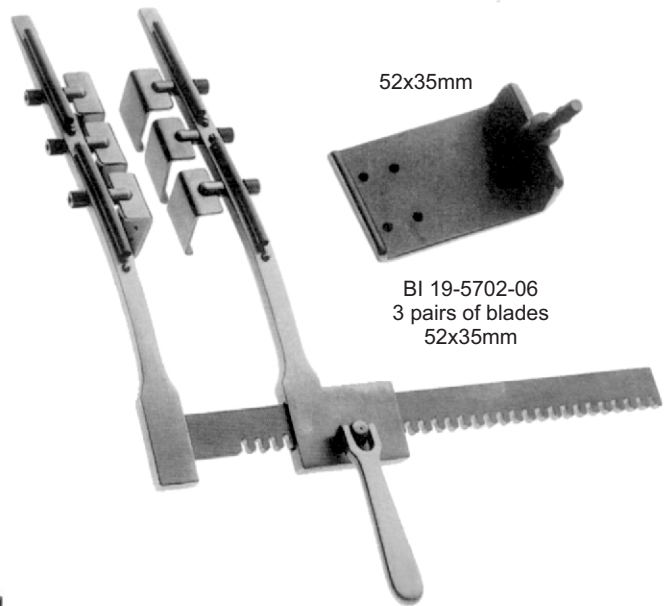

<b>ANKENEY</b>	<b>a</b>	<b>b</b>	<b>c</b>
<b>S/S</b>			
BI 19-5702-01	52mm	35mm	178mm

52x35mm

BI 19-5702-06  
 3 pairs of blades  
 52x35mm



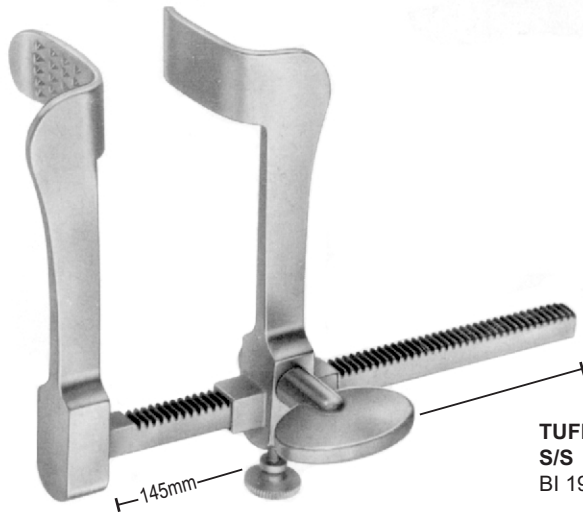

**TUFFIER**  
S/S  
BI 19-5703-14    a    b    c  
32mm    19mm    110mm

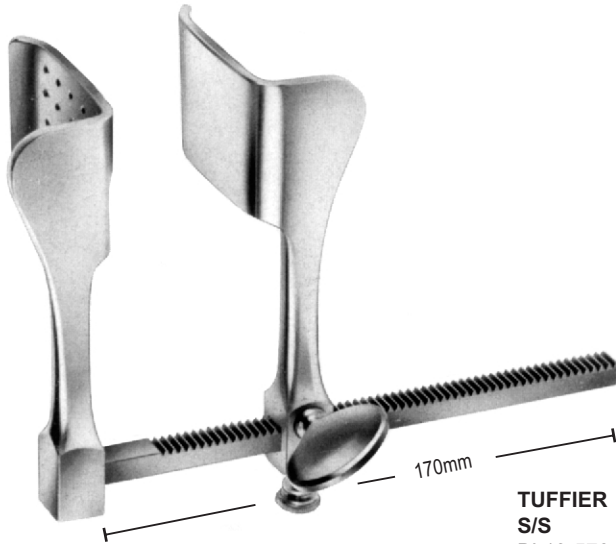

**TUFFIER**  
S/S  
BI 19-5704-17    a    b    c  
43mm    53mm    130mm

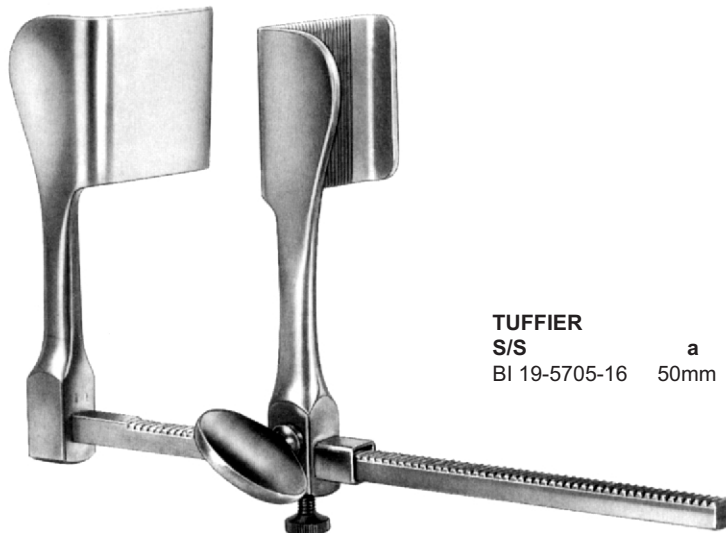

**TUFFIER**  
S/S  
BI 19-5705-16    a    b    c  
50mm    45mm    165mm



Rib Spreaders ● EN  
 Rippensperrer ● DE  
 Separadores costales ● ES  
 LaÉpandeurs de côtes ● FR  
 Spalmatori di costole ● IT



**HAIGHT**  
**S/S**  
 BI 19-5706-14    a    b    c  
                          30mm   30mm   90mm

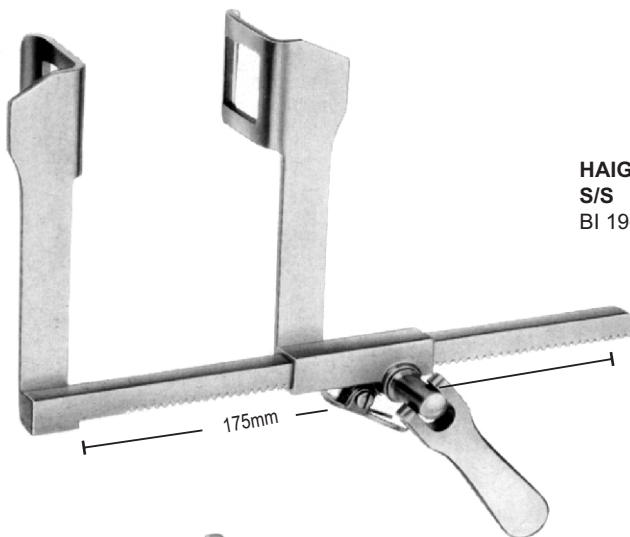

**HAIGHT**  
**S/S**  
 BI 19-5707-15    a    b    c  
                          30mm   30mm   115mm



**HERTZLER**  
**S/S**  
 BI 19-5708-15    a    b    c  
                          20mm   25mm   105mm



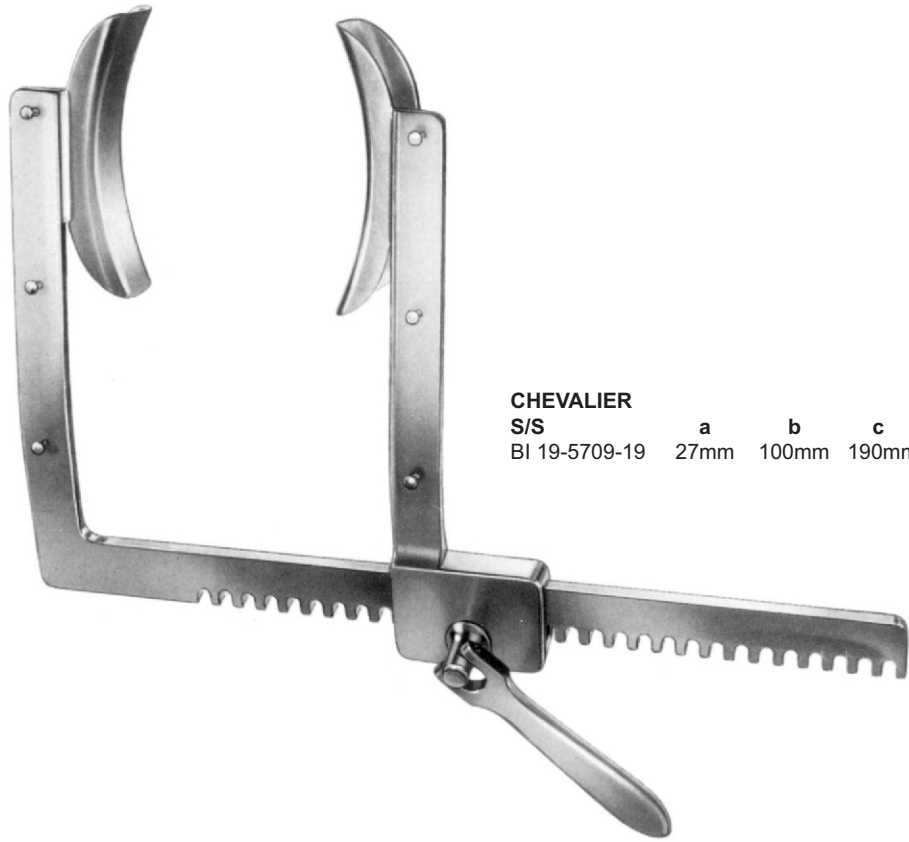

**CHEVALIER**  
S/S  
BI 19-5709-19    a    b    c  
                         27mm 100mm 190mm

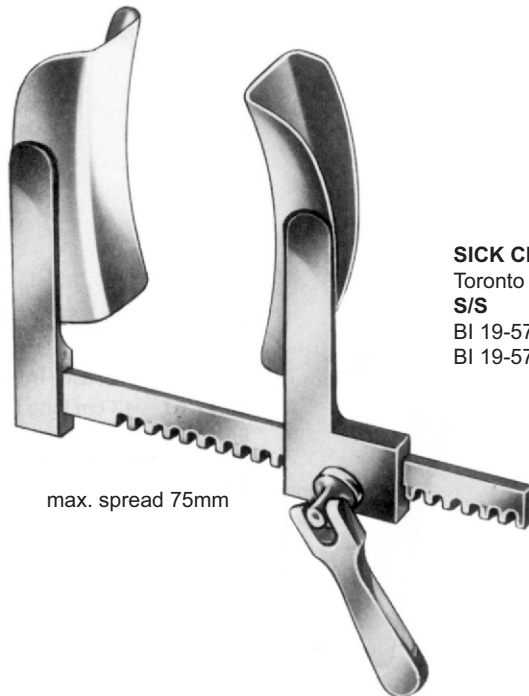

**SICK CHILDREN HOSPITAL**  
Toronto  
S/S  
BI 19-5710-01 (child)    a    b    c  
                                 20mm 40mm 75mm  
BI 19-5710-02 (adult)    20mm 60mm 75mm

max. spread 75mm



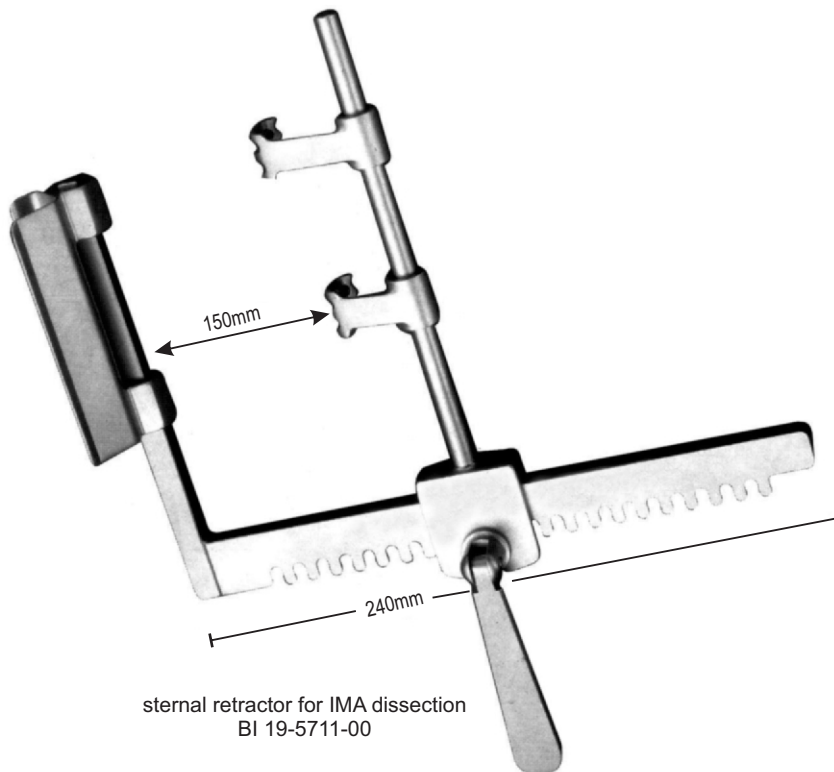

sternal retractor for IMA dissection  
 BI 19-5711-00



Carpenter's thoracic retractor  
 (adult)  
 BI 19-5712-00 complete



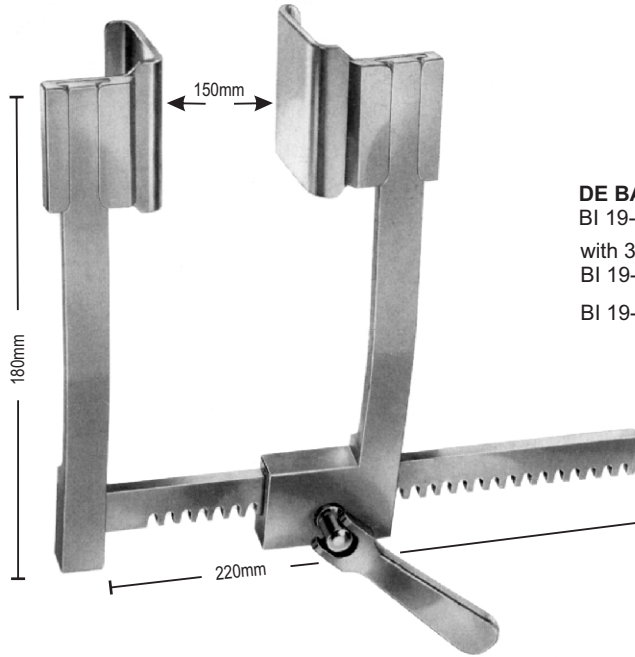

**DE BAKY**  
BI 19-5713-00  
with 3 pairs of blades  
BI 19-5713-01  
BI 19-5713-22 spreader only

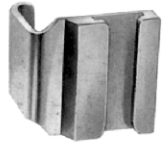
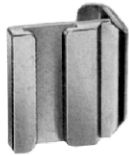

Blades  
BI 19-5713-01  
30 x 30 mm

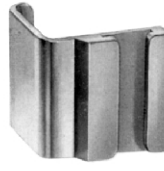

Blades  
BI 19-5713-02  
40 x 40 mm

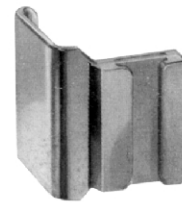

Blades  
BI 19-5713-03  
50 x 50 mm

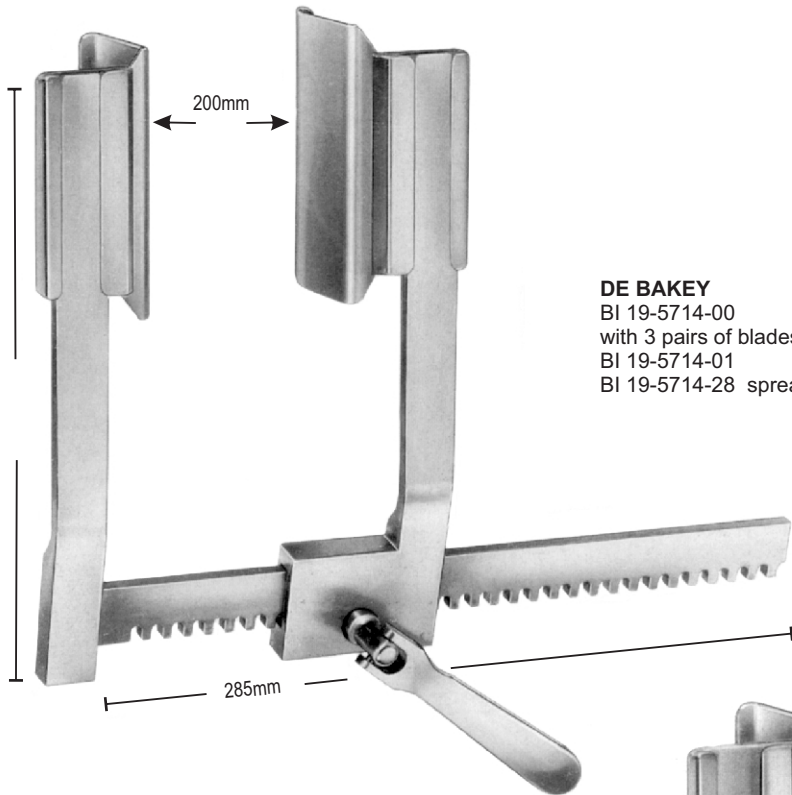

**DE BAKEY**  
 BI 19-5714-00  
 with 3 pairs of blades  
 BI 19-5714-01  
 BI 19-5714-28 spreader only

blades  
 BI 19-5714-01  
 60 x 60 mm

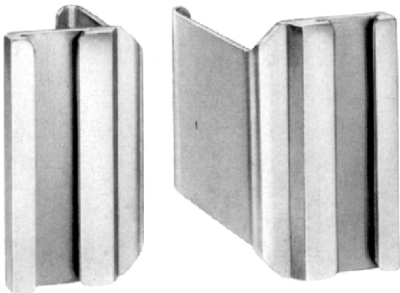

blades  
 BI 19-5714-02  
 50 x 80 mm

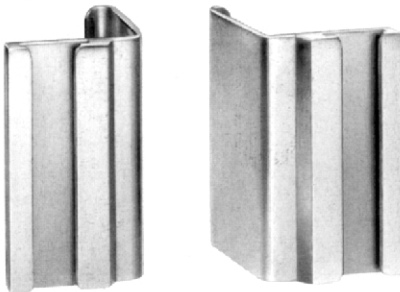

blades  
 BI 19-5714-03  
 40 x 100 mm

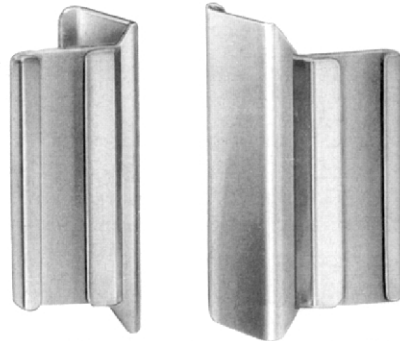

blades  
 BI 19-5714-04  
 80 x 60 mm

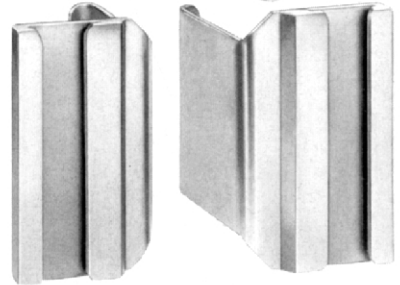

blades  
 BI 19-5714-05  
 50 x 66 mm



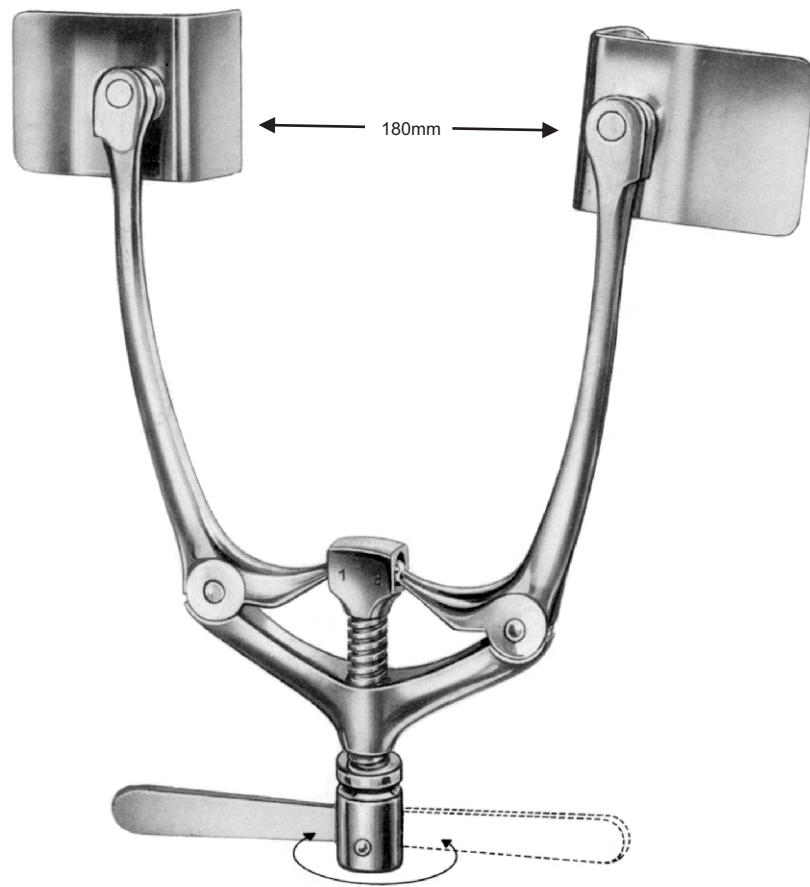

**QUERVAIN**  
BI 19-5715-00  
35 X 50 X 180 mm

Rib Spreaders ● EN  
 Rippensperrer ● DE  
 Separadores costales ● ES  
 LaÉpandeurs de côtes ● FR  
 Spalmatori di costole ● IT



42 x 65 mm

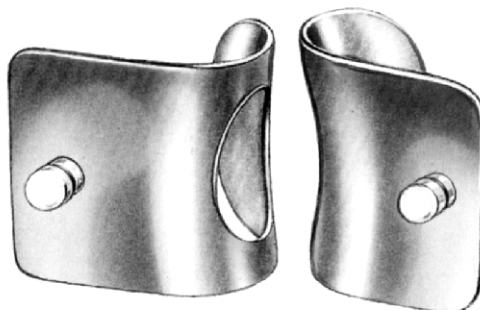

BI 19-5716-65

75 x 75 mm

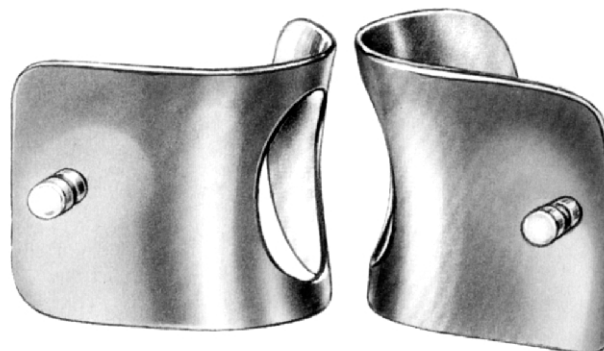

BI 19-5716-75

BI 19-5716-00 complete consisting of:  
 BI 19-5716-01 retractor only  
 BI 19-5716-65 1 pair blades 42x65mm  
 BI 19-5716-75 1 pair blades 75x75mm





**Lemmon**  
BI 19-5744-18 18 cm/7"  
BI 19-5744-14 14 cm/5 ½

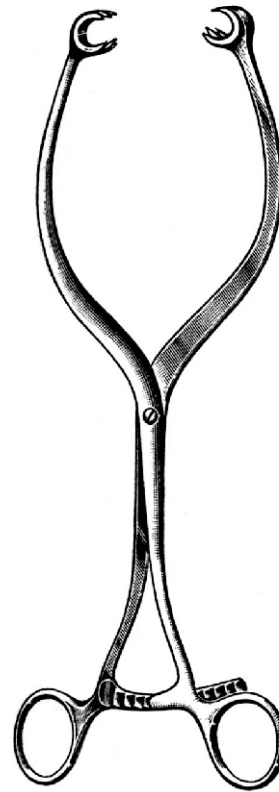

**CRAFOORD**  
BI 19-5744-28  
28.0cm

Rib Contractors, Lung Spatulas  
 Rippenkontraktoren, Lungenspatel  
 Aproximadores para costillas, Espátula pulmonar  
 Entrepreneurs en côtes, Spatules pulmonaires  
 Appaltatori delle costole, spatole polmonari

● EN  
 ● DE  
 ● ES  
 ● FR  
 ● IT

CARDIOVASCULAR



**Sellors**  
 BI 19-5745-19  
 19 cm/7½"



**Bailey-Baby**  
 BI 19-5746-14  
 14 cm/5½"





**Bailey**  
BI 19-5747-16 16 cm/6  $\frac{3}{4}$ "  
BI 19-5747-20 20 cm/8"



**Bailey-Gibbon**  
BI 19-5748-16 16 cm/6  $\frac{3}{4}$ "  
BI 19-5748-20 20 cm/8"



**Allison**  
BI 19-5749-25 25.5 cm/10"  
BI 19-5749-30 30.0 cm/12"  
BI 19-5749-32 32.0 cm/13"

Lung Spatulas

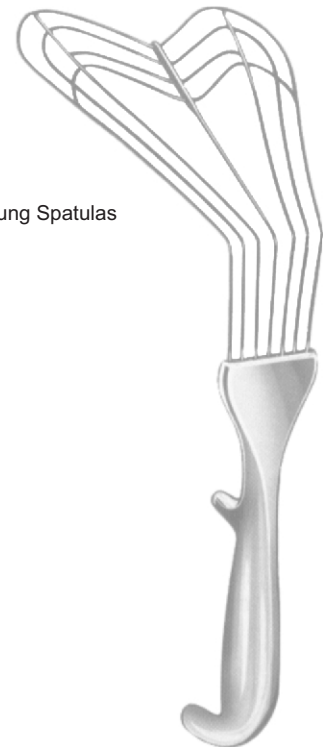

BI 19-5750-30  
30 cm/12"



ATRAUMA

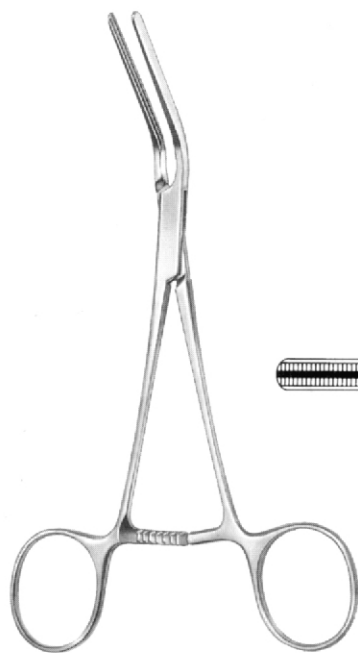
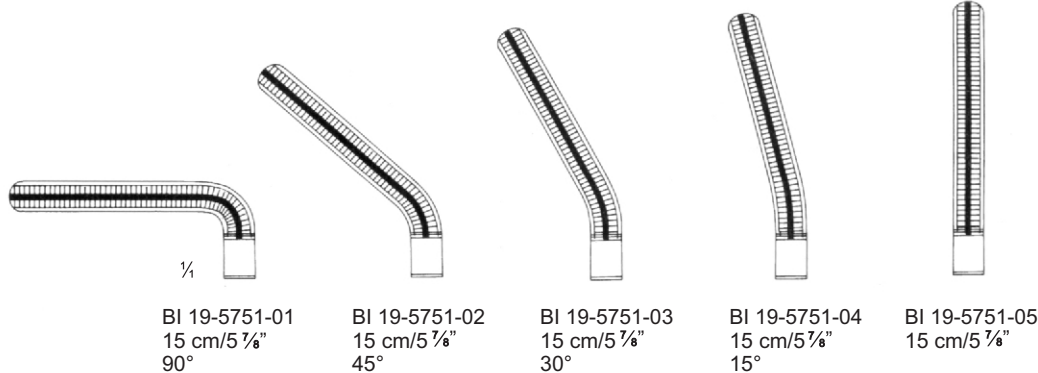

DARDIK

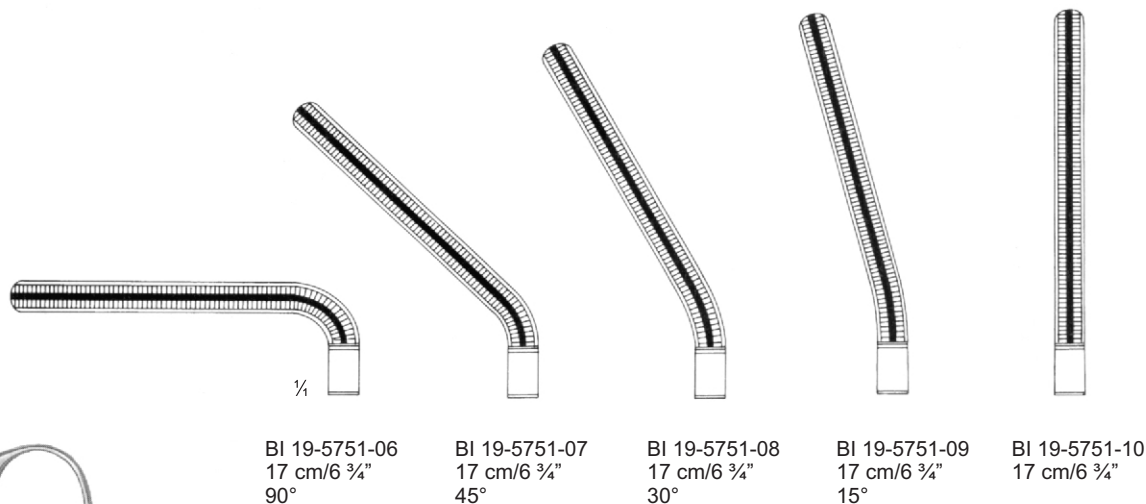



½

**DALE**  
BI 19-5752-18  
18 cm/7 ¼"

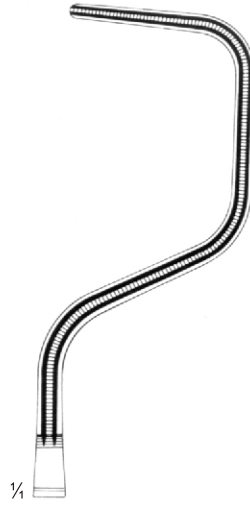

ATRAUMA

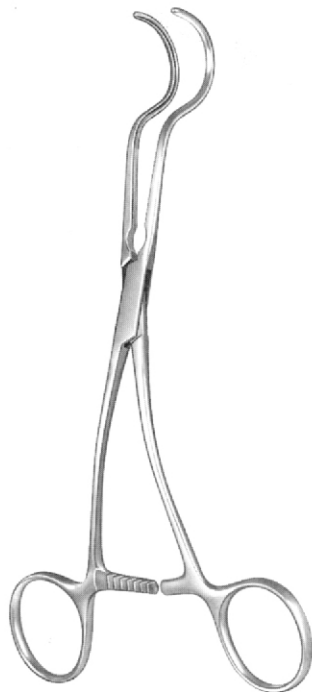

**DALE**

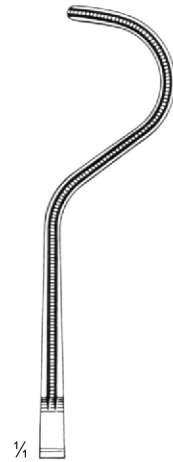

BI 19-5753-17  
17.5 cm/6 ¾"

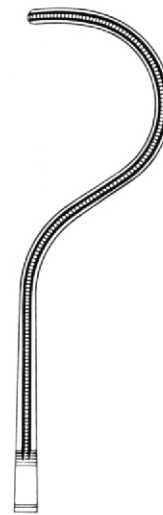

BI 19-5753-18  
18 cm/7 ¼"

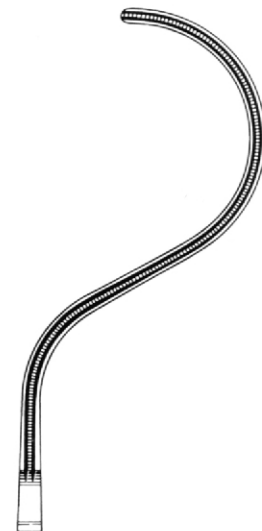

BI 19-5753-19  
19 cm/7 ½"

ATRAUMA

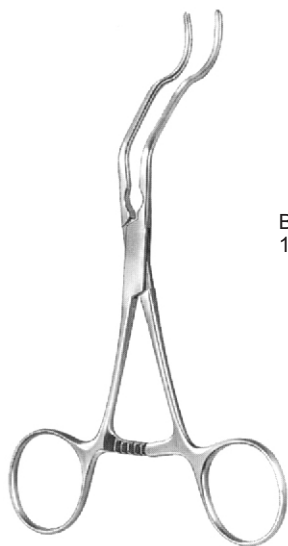

GREGORY

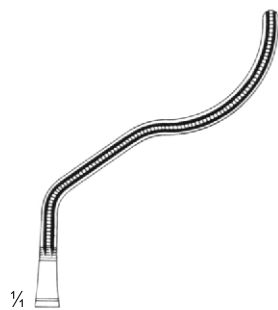

BI 19-5754-14  
 14 cm/5 1/2"

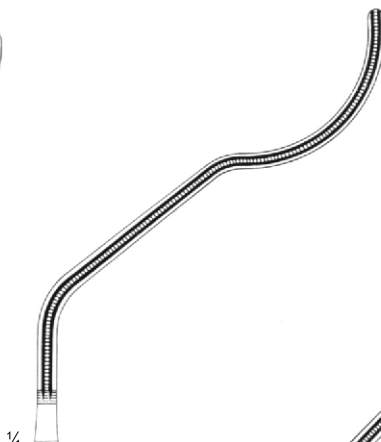

BI 19-5754-16  
 16 cm/6 1/4"

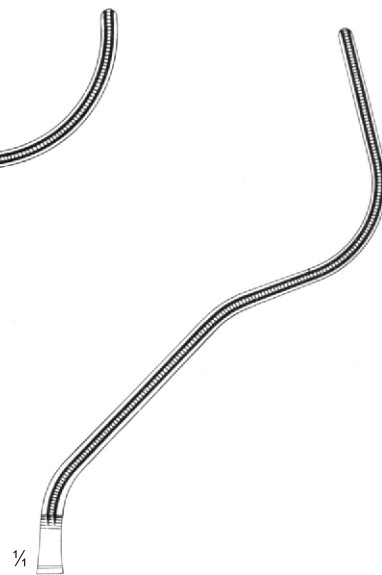

BI 19-5754-18  
 18 cm/7 1/8"



ATRAUMA



**JAVID**  
BI 19-5755-18  
18 cm/6 7/8"

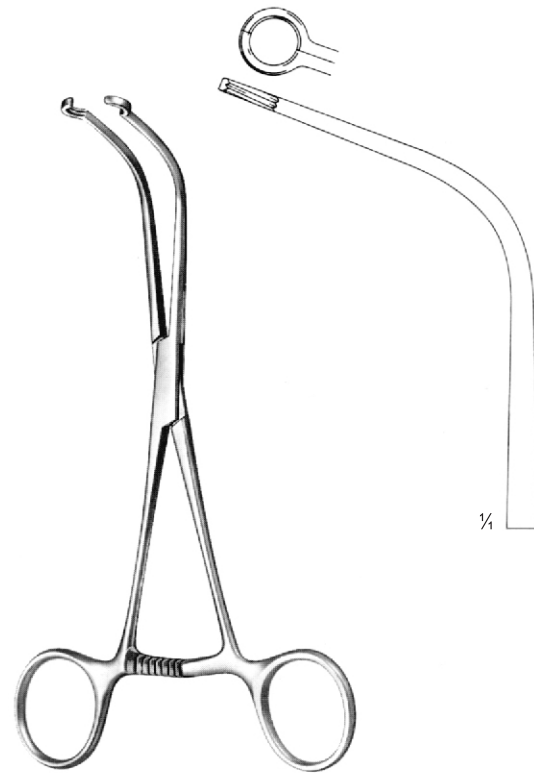

**JAVID**  
BI 19-5756-19  
19 cm/7 1/4"

ATRAUMA

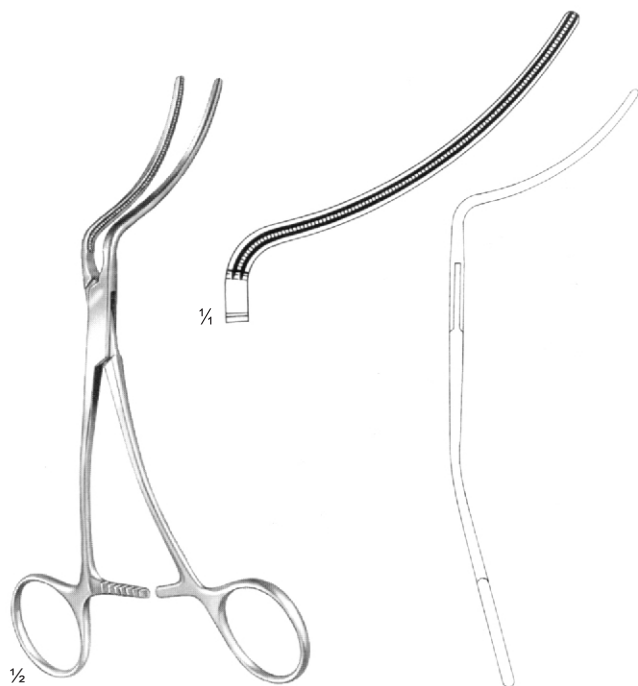

$\frac{1}{2}$   
**Dardik**  
 BI 19-5757-16  
 16 cm/6  $\frac{1}{4}$ "

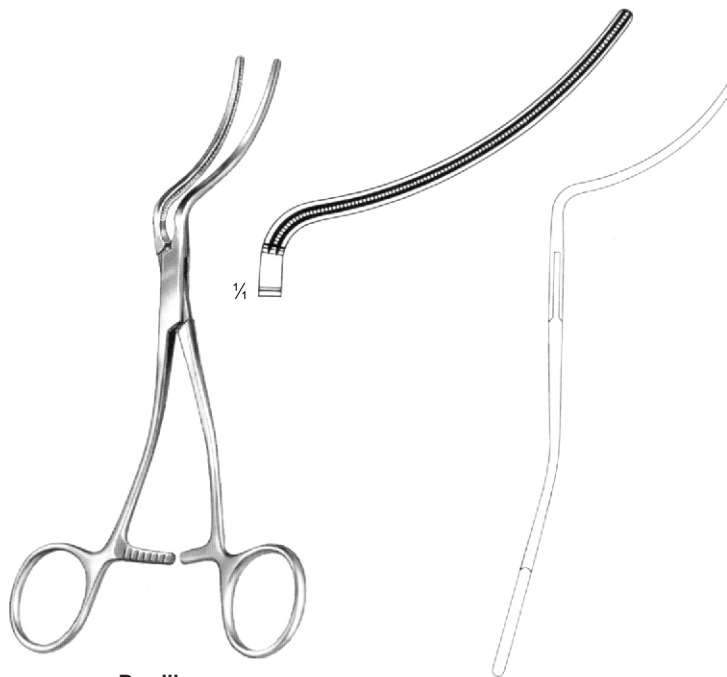

$\frac{1}{2}$   
**Dardik**  
 BI 19-5758-17  
 17 cm/6  $\frac{3}{4}$ "

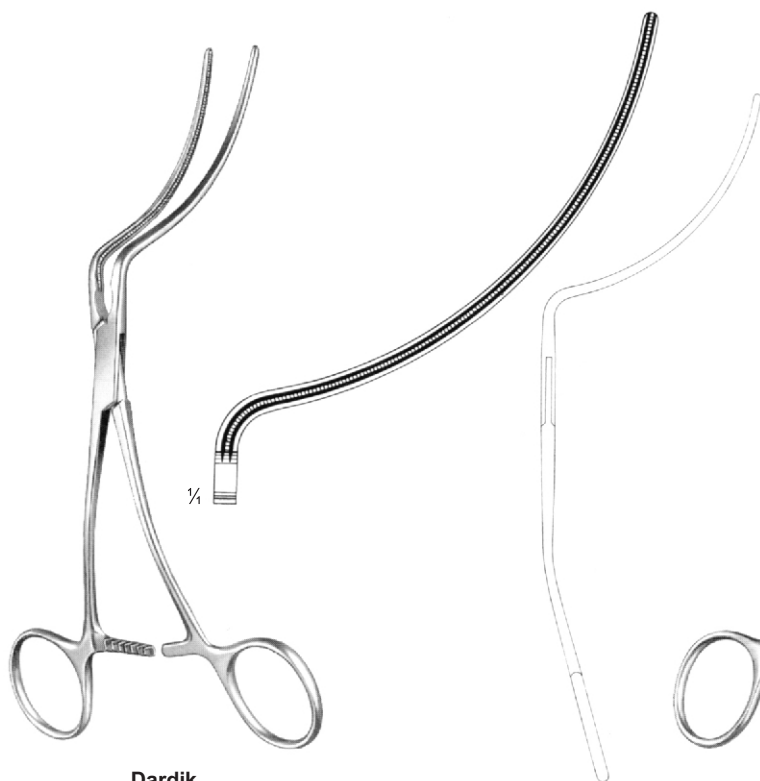

$\frac{1}{2}$   
**Dardik**  
 BI 19-5759-18  
 18 cm/7  $\frac{1}{8}$ "

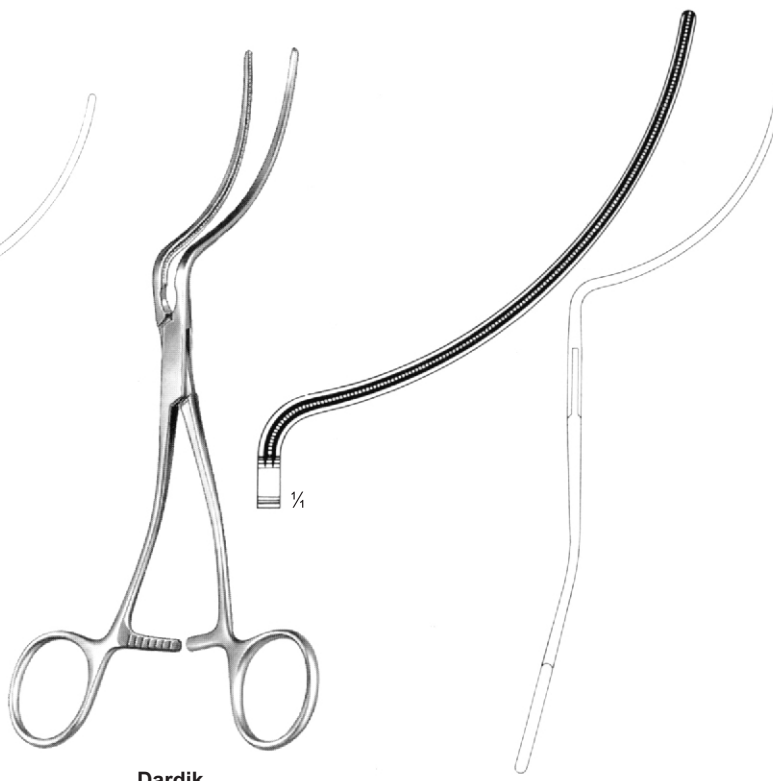

$\frac{1}{2}$   
**Dardik**  
 BI 19-5760-19  
 19.5 cm/7  $\frac{3}{4}$ "



ATRAUMA

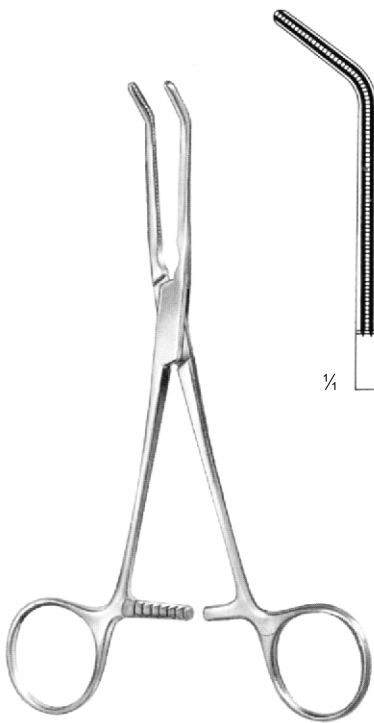

**HUSFELDT**  
BI 19-5761-17  
17.5 cm/6 7/8"

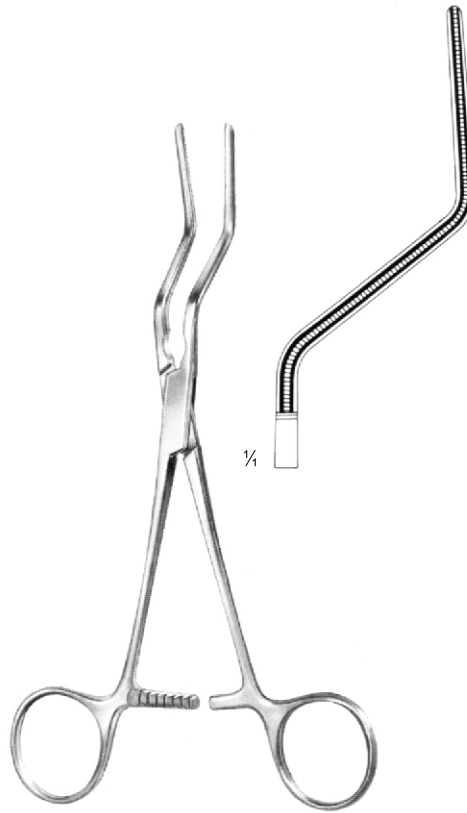

**HUSFELDT**  
BI 19-5762-18  
18 cm/7 1/8"

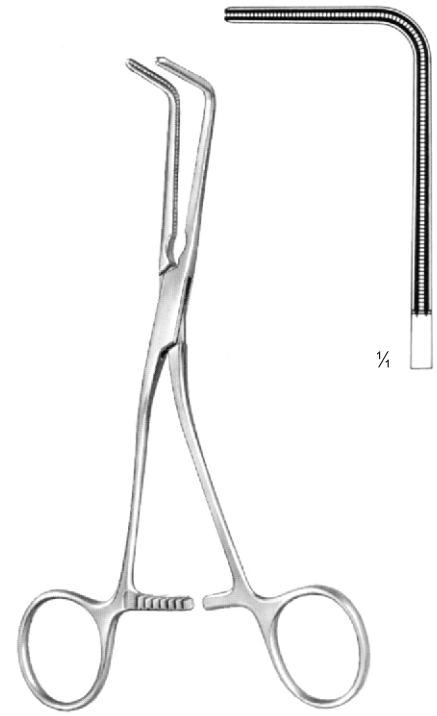

**HUSFELDT**  
BI 19-5763-17  
17 cm/6 3/4"

Vascular Measuring Device ● EN  
 Gefäß-Messzirkel ● DE  
 Compas Para medir Vasos ● ES  
 Appareil de mesure vasculaire ● FR  
 Dispositivo di misurazione vascolare ● IT

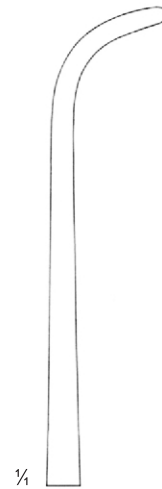
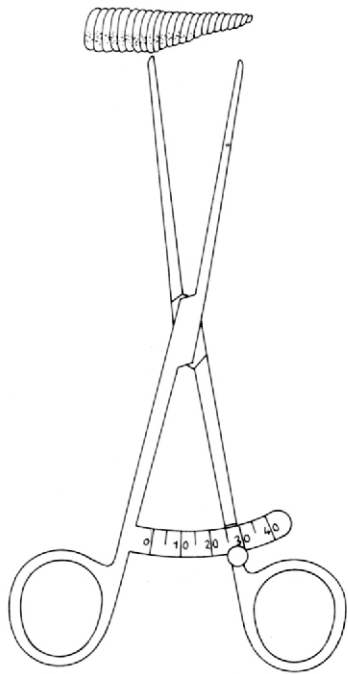

BI 19-5764-17  
 17 cm/6  $\frac{3}{4}$ "  
 Vascular Measuring Device





**ATRAUMA**

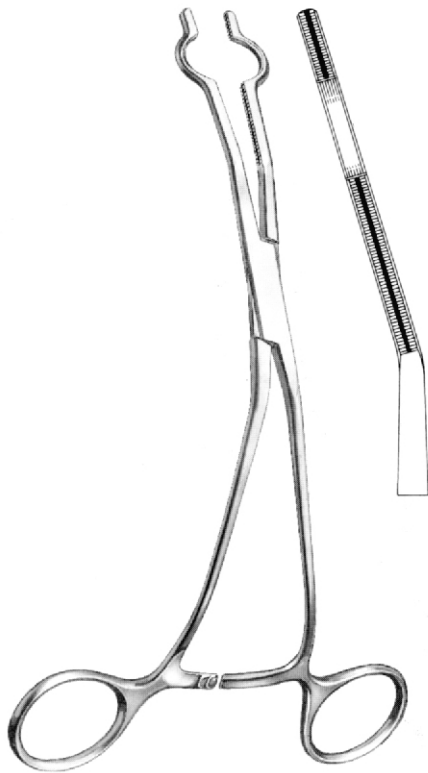

**COOLEY**



BI 19-5765-01  
17 cm/6 3/4"  
20 Charr.



BI 19-5765-02  
17 cm/6 3/4"  
24 Charr.



BI 19-5765-03  
17 cm/6 3/4"  
26 Charr.



BI 19-5765-04  
20 cm/7 7/8"  
28 Charr.



BI 19-5765-05  
20 cm/7 7/8"  
30 Charr.

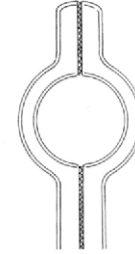

BI 19-5765-06  
20 cm/7 7/8"  
32 Charr.



BI 19-5765-07  
20 cm/7 7/8"  
36 Charr.

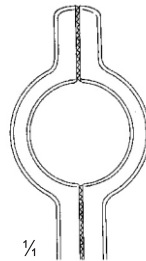

BI 19-5765-08  
20 cm/7 7/8"  
38 Charr.

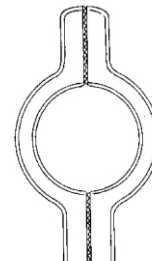

BI 19-5765-09  
20 cm/7 7/8"  
40 Charr.



ATRAUMA

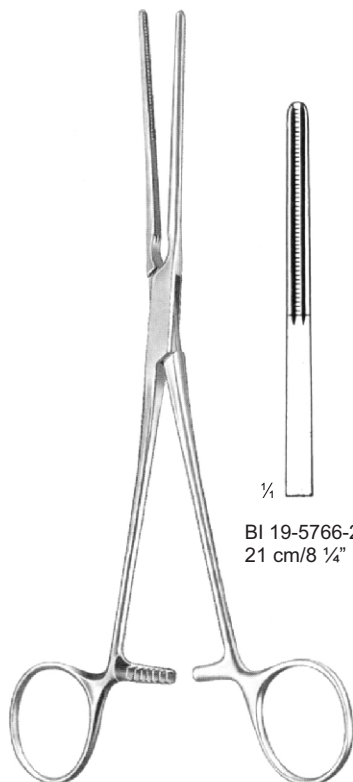

BI 19-5766-21  
 21 cm/8 1/4"

POTTS

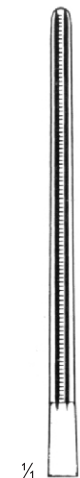

BI 19-5766-22  
 22.5 cm/8 3/4"

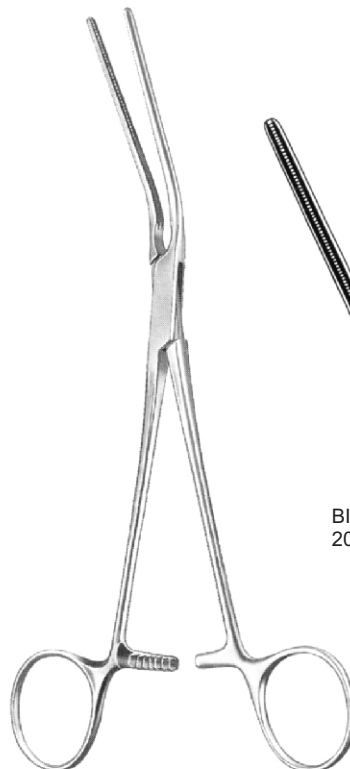

BI 19-5767-20  
 20.5 cm/8 1/8"

POTTS

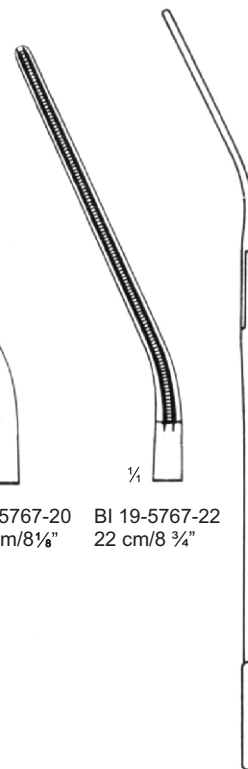

BI 19-5767-22  
 22 cm/8 3/4"

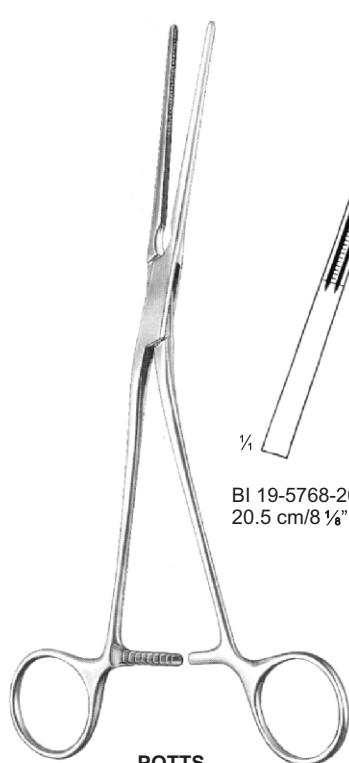

BI 19-5768-20  
 20.5 cm/8 1/8"

POTTS

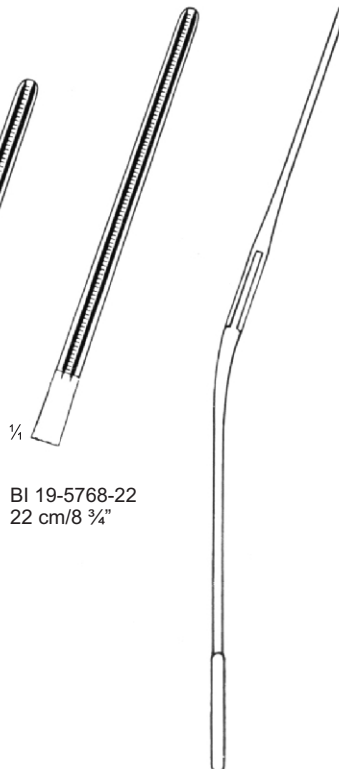

BI 19-5768-22  
 22 cm/8 3/4"



ATRAUMA



**POTTS-GLOVER**  
BI 19-5769-21  
21.5 cm/8 1/2"

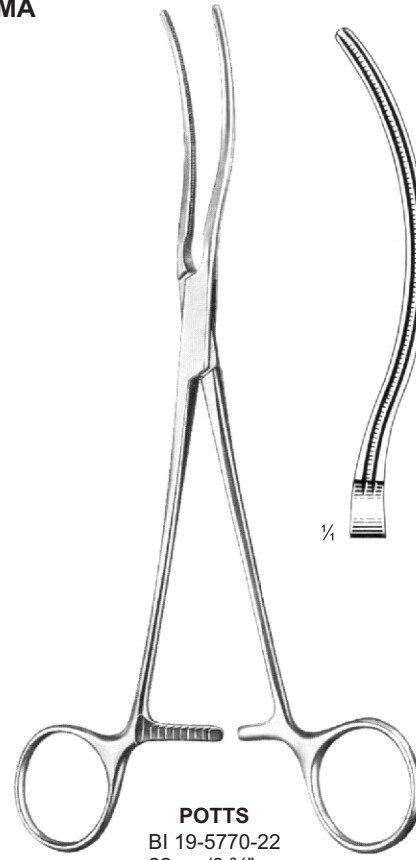

**POTTS**  
BI 19-5770-22  
22 cm/8 3/4"

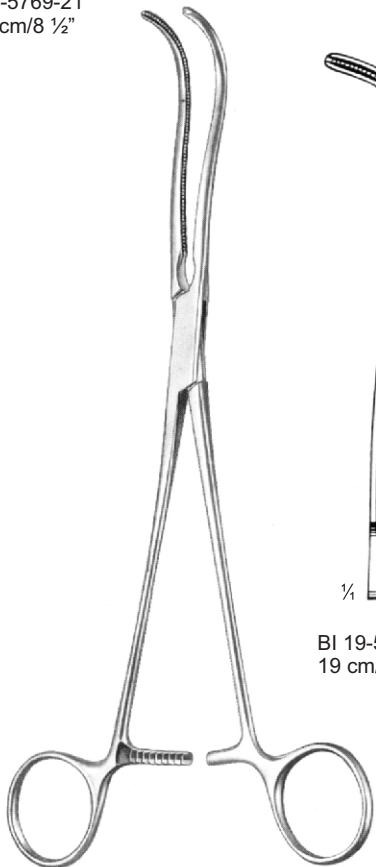

**DEBAKEY**  
Dissecting and Ligature Forceps



BI 19-5771-19  
19 cm/7 1/2"

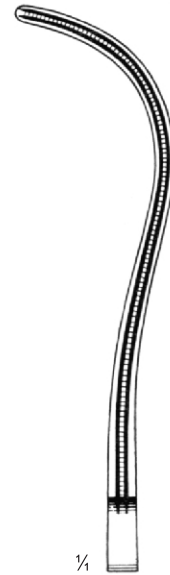

BI 19-5771-24  
24 cm/9 1/2"



ATRAUMA

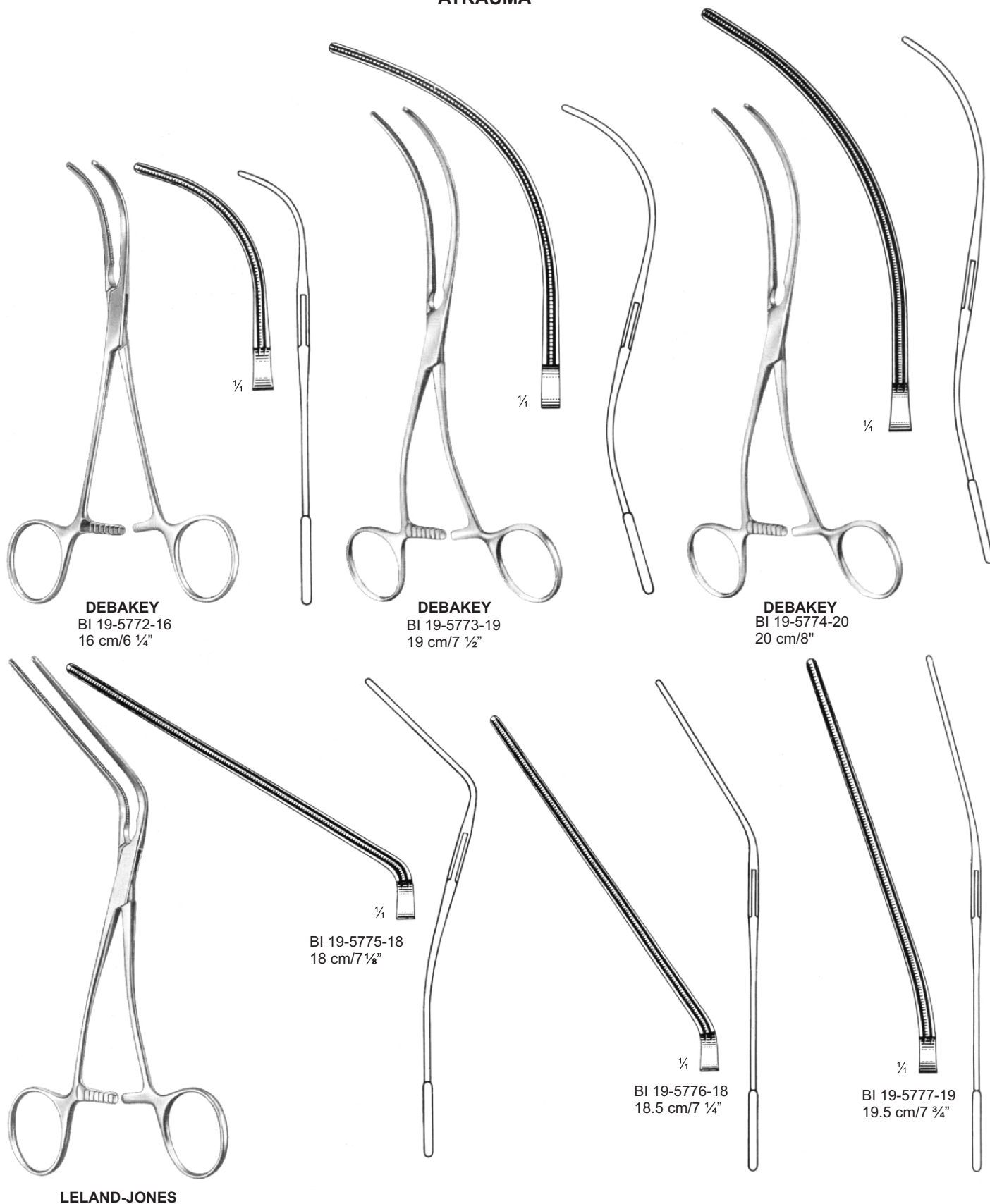

**DEBAKEY**  
 BI 19-5772-16  
 16 cm/6 1/4"

**DEBAKEY**  
 BI 19-5773-19  
 19 cm/7 1/2"

**DEBAKEY**  
 BI 19-5774-20  
 20 cm/8"

BI 19-5775-18  
 18 cm/7 1/8"

**LELAND-JONES**

BI 19-5776-18  
 18.5 cm/7 1/4"

BI 19-5777-19  
 19.5 cm/7 3/4"

ATRAUMA

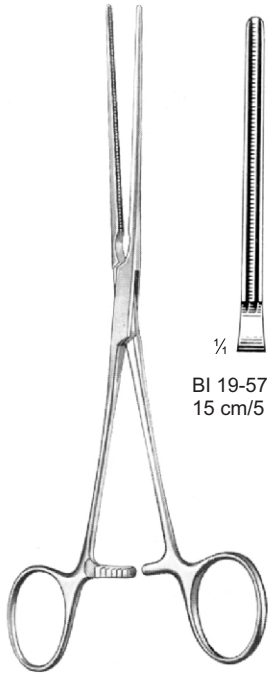

BI 19-5778-15  
15 cm/5 7/8"

BAINBRIDGE



BI 19-5778-18  
18.5 cm/7 1/4"

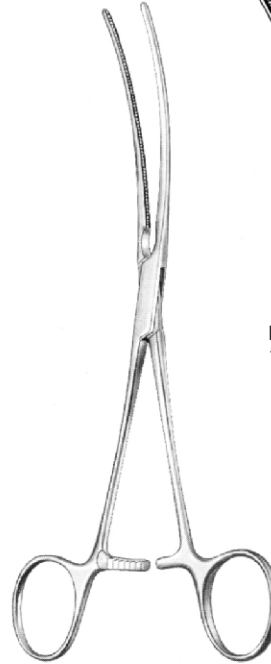

BI 19-5779-15  
15 cm/5 7/8"

BAINBRIDGE



BI 19-5779-18  
18.5 cm/7 1/4"

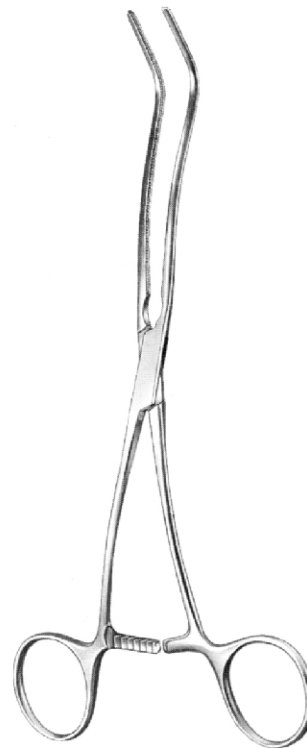

DEBAKEY  
BI 19-5780-20  
20 cm/7 7/8"

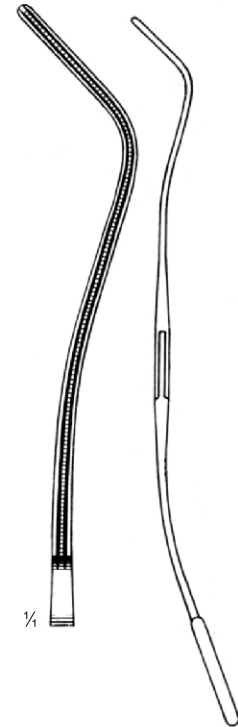

ATRAUMA



DEBAKEY

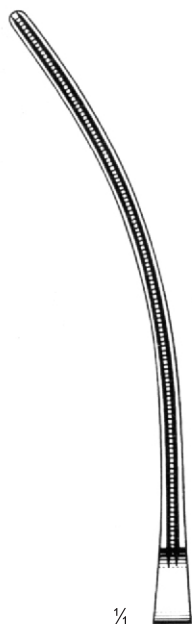

BI 19-5781-26  
 26 cm/10 ¼"

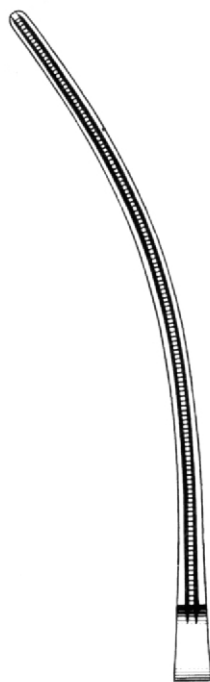

BI 19-5782-27  
 27 cm/10 ½"

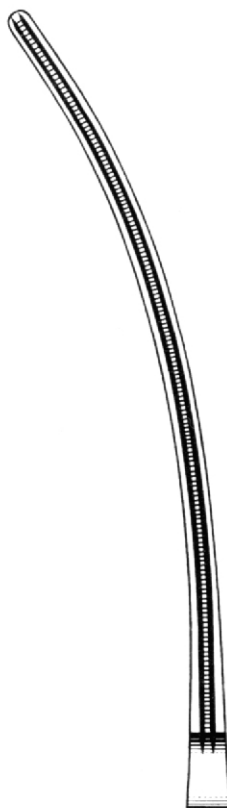

BI 19-5783-31  
 31 cm/12 ¼"



BI 19-5784-33  
 33 cm/13"

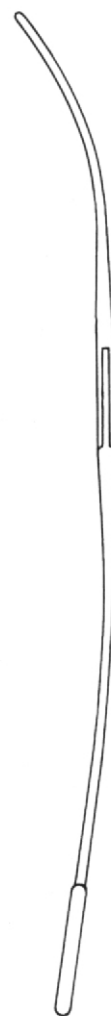



**ATRAUMA**



**DEBAKEY**  
BI 19-5785-28  
28 cm/11"

**DEBAKEY**  
BI 19-5786-30  
30 cm/11 3/4"

Aortic Clamps, Ligature Forceps  
 Aortaklemmen, Ligaturklemmen  
 Pinzas aórticas, Pinzas para ligaduras  
 Pincès aortiques, pincès à ligature  
 Morsetti aortici, pinze per legature

- EN
- DE
- ES
- FR
- IT

ATRAUMA

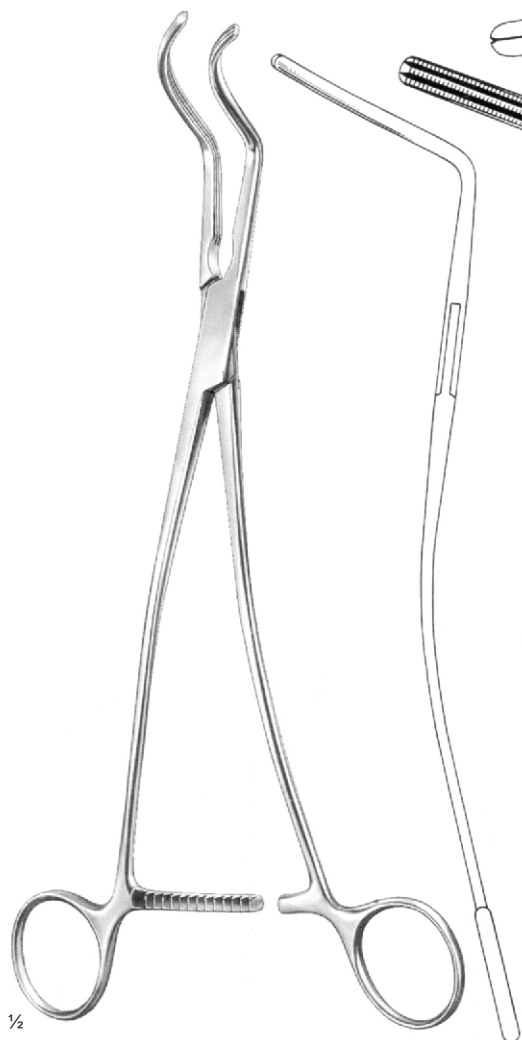

**DEBAKEY**  
 BI 19-5787-27  
 27 cm/10 1/2"

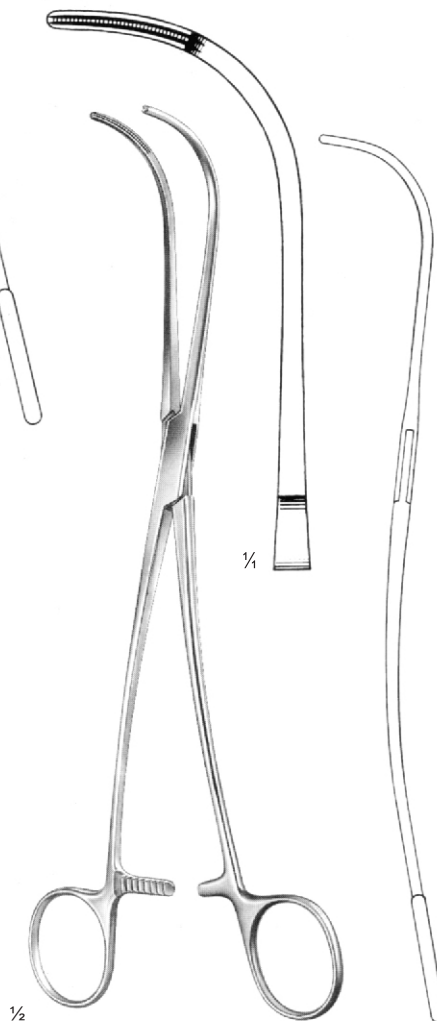
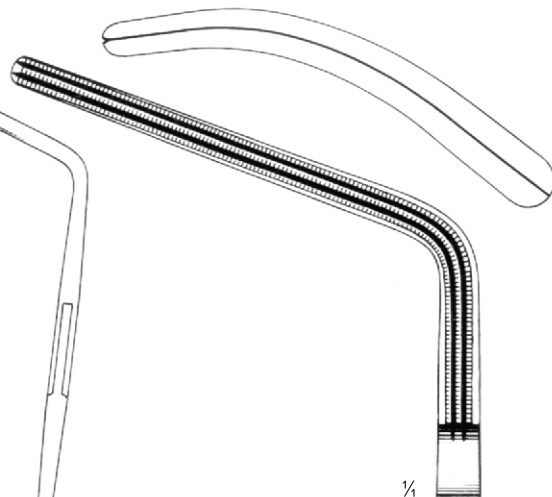

**DEBAKEY**  
 BI 19-5788-24  
 24.5 cm/9 5/8"

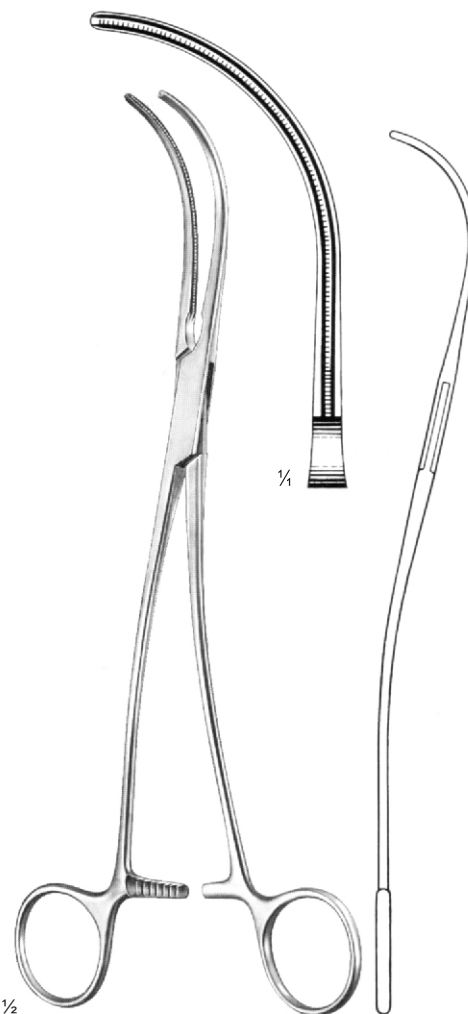

**DEBAKEY**  
 BI 19-5789-24  
 24.5 cm/9 5/8"





ATRAUMA

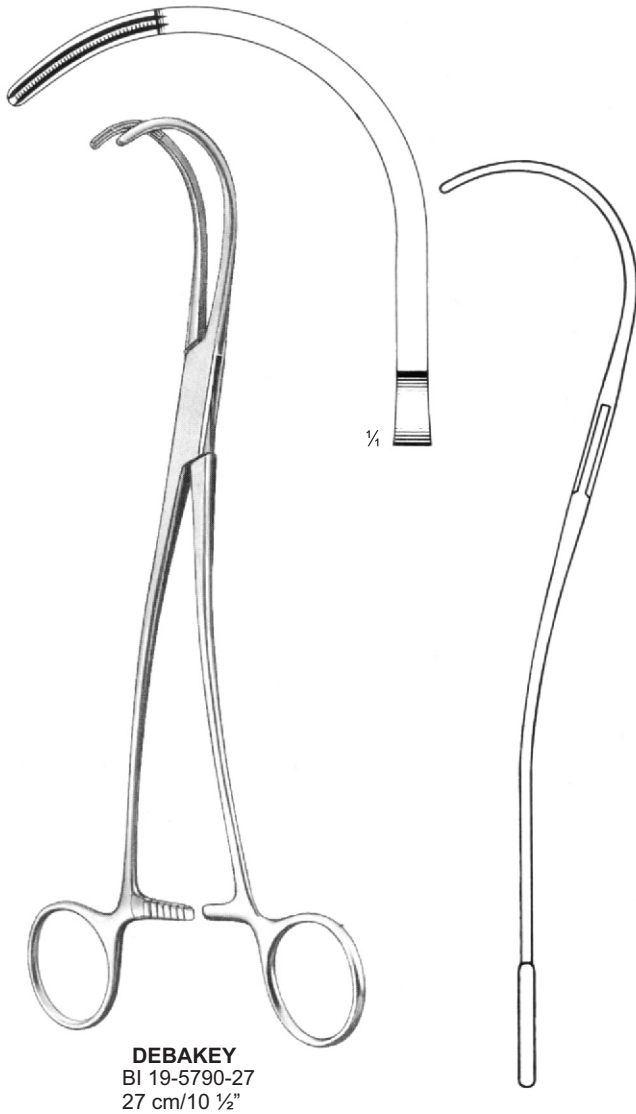

**DEBAKEY**  
BI 19-5790-27  
27 cm/10 ½"



**DEBAKEY**  
BI 19-5791-27  
27 cm/10 ½"



ATRAUMA

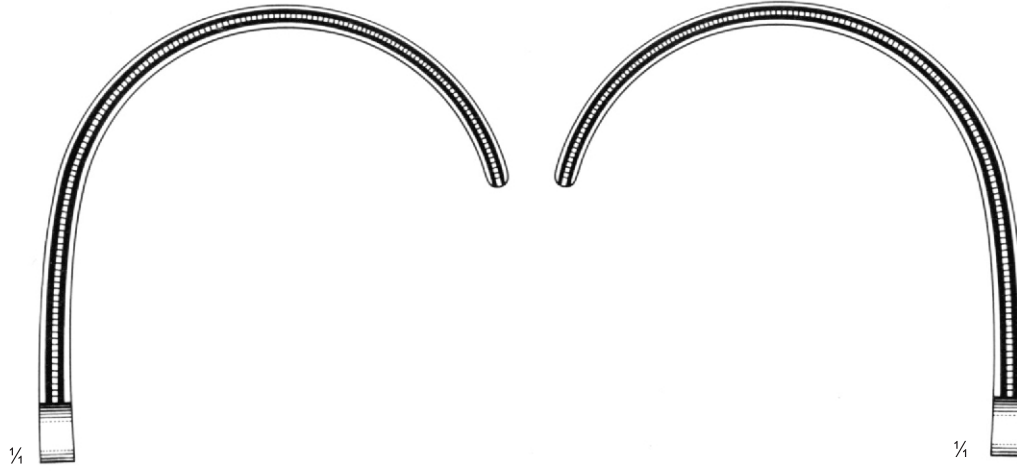

**WEBER**  
 BI 19-5792-24  
 24 cm/9 1/2"



**WEBER**  
 BI 19-5793-24  
 24 cm/9 1/2"



ATRAUMA

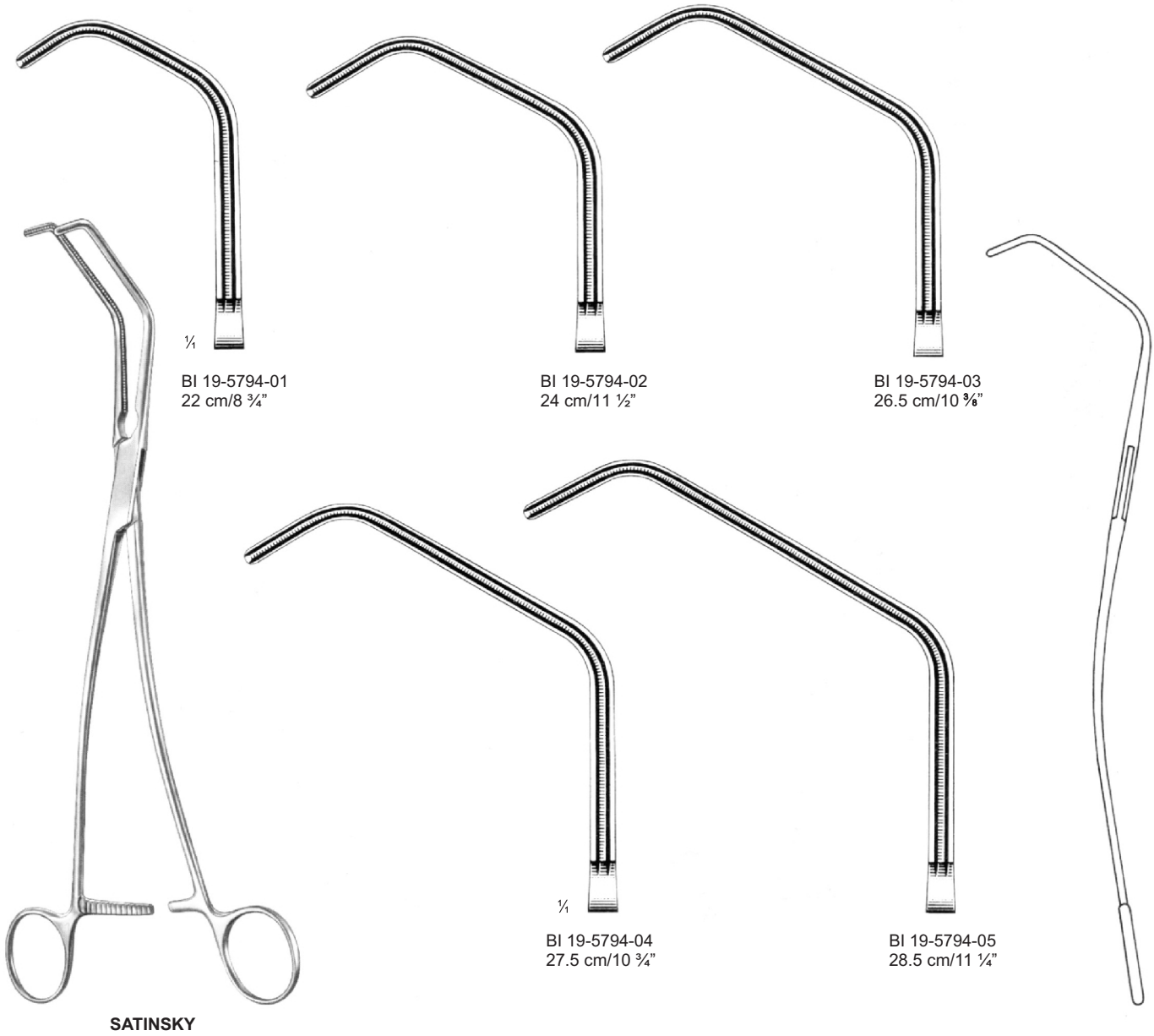

¼  
 BI 19-5794-01  
 22 cm/8 ¾"

BI 19-5794-02  
 24 cm/11 ½"

BI 19-5794-03  
 26.5 cm/10 ¼"

¼  
 BI 19-5794-04  
 27.5 cm/10 ¾"

BI 19-5794-05  
 28.5 cm/11 ¼"

SATINSKY

ATRAUMA



HARKEN



BI 19-5795-01  
 24.5 cm/9 5/8"

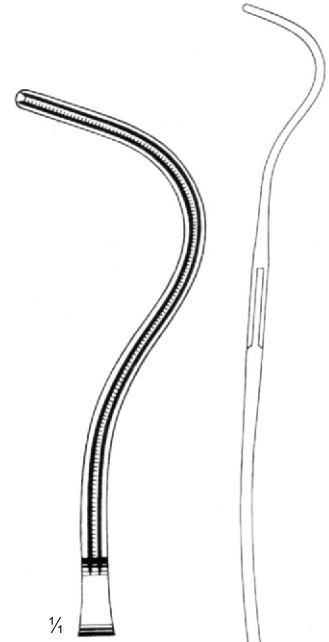

BI 19-5795-02  
 24 cm/9 1/2"

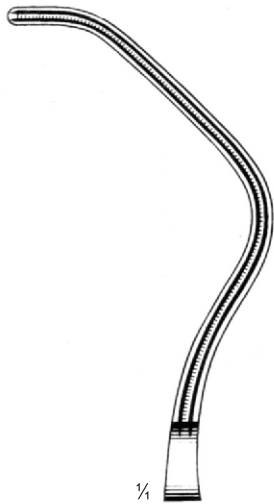

BI 19-5795-03  
 23 cm/9"

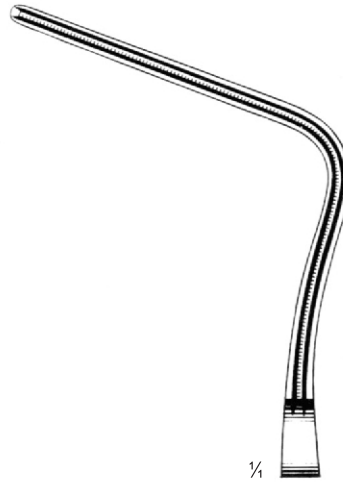

BI 19-5795-04  
 23.5 cm/9 1/4"



**ATRAUMA**



BI 19-5797-25  
25.5 cm/10"

BI 19-5797-23  
23 cm/9"

**LEES**

Bronchus Clamps ● EN  
 Bronchusklemmen ● DE  
 Pinzas bronquiales ● ES  
 Pincès à bronches ● FR  
 Morsetti per bronchi ● IT

**ATRAUMA**

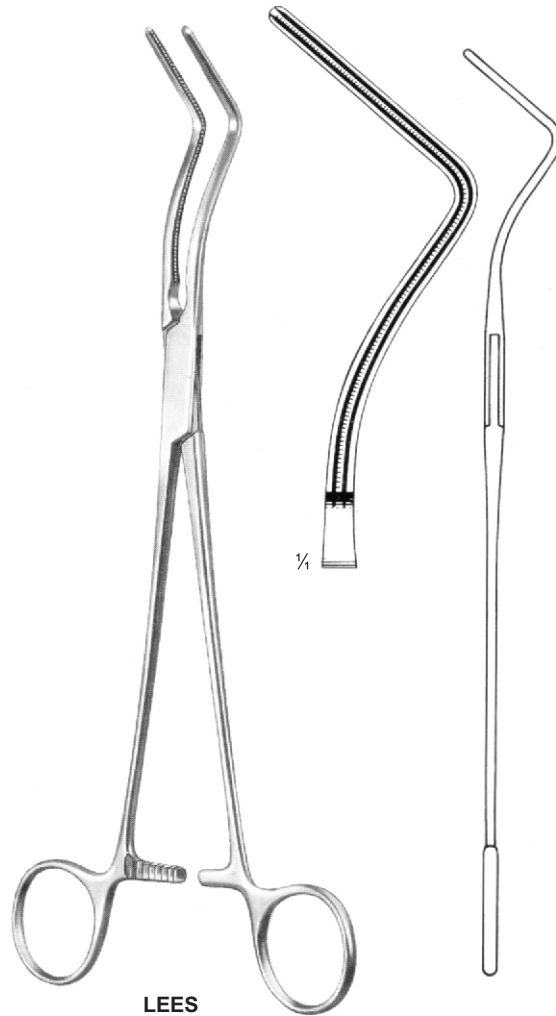

**LEES**

BI 19-5798-25  
 25 cm/9 7/8"



**ATRAUMA**



**LAMBERT-KAY**

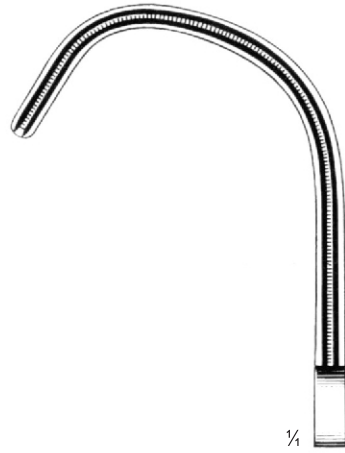

BI 19-5799-01  
22.5 cm/8 3/4"

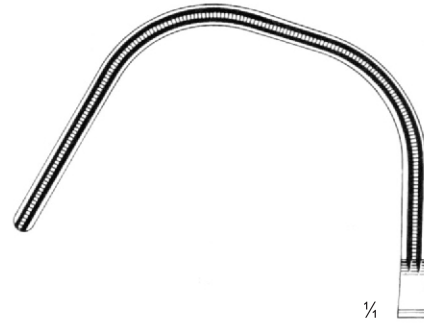

BI 19-5799-02  
22.5 cm/8 3/4"

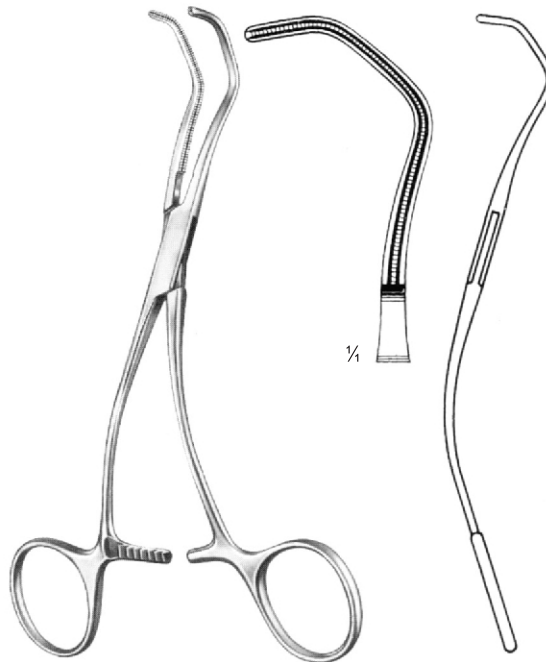
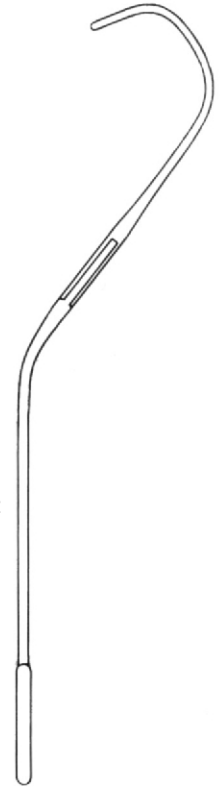

**DEBAKEY**  
BI 19-5800-16  
16.5 cm/6 1/2"



**ATRAUMA**



BI 19-5801-18  
 18.5 cm/7 1/4"

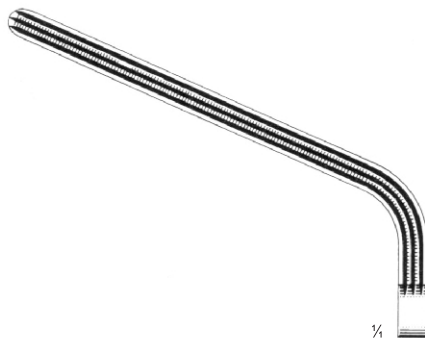

BI 19-5801-20  
 20 cm/7 7/8"

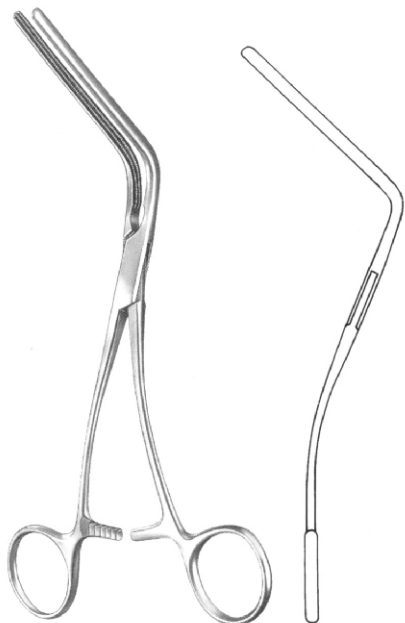

**MORRIS-DEBAKEY**

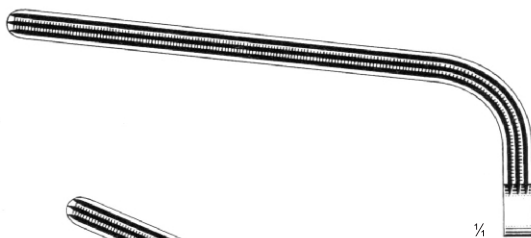

BI 19-5801-26  
 26 cm/10 1/4"

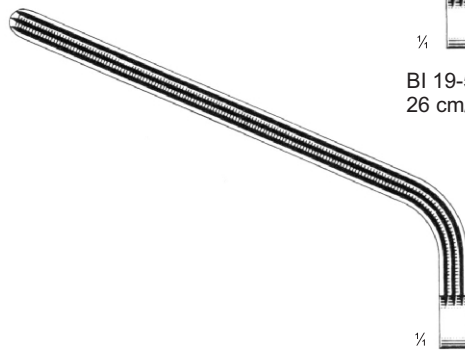

BI 19-5801-27  
 27.5 cm/10 3/4"





**ATRAUMA**



**DEBAKEY-BAHNSON**

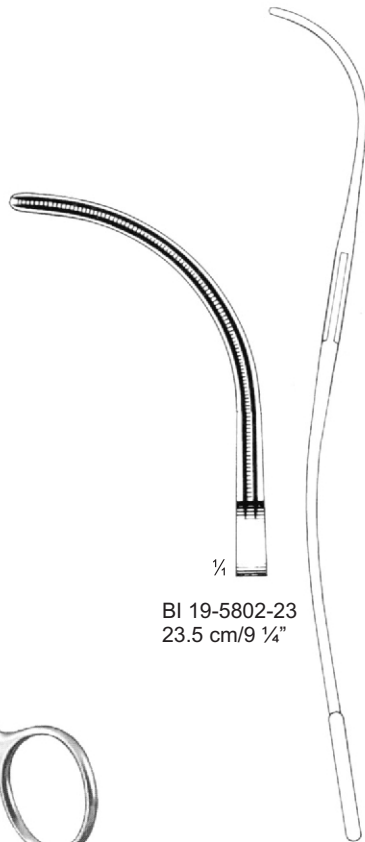

BI 19-5802-23  
23.5 cm/9 1/4"

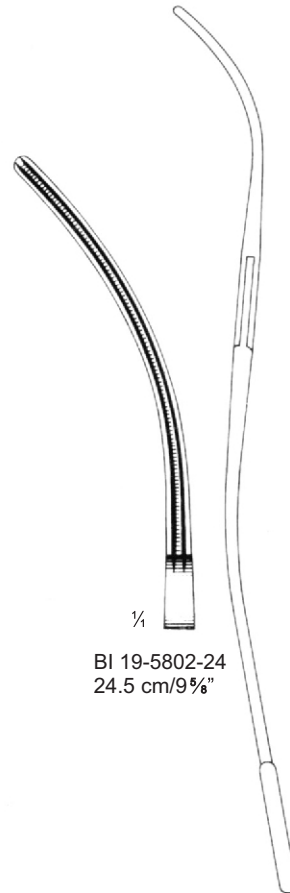

BI 19-5802-24  
24.5 cm/9 5/8"

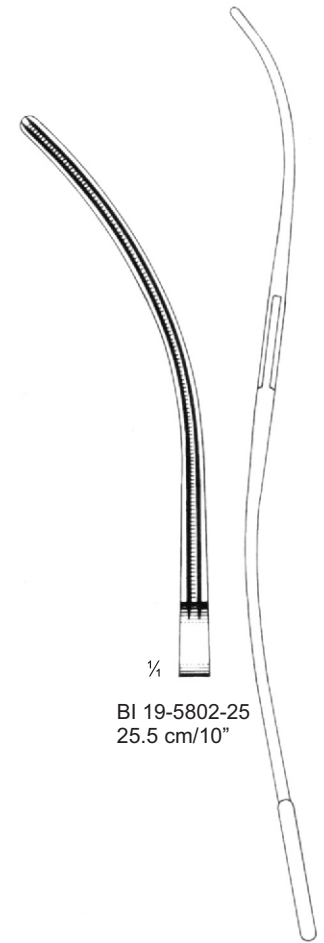

BI 19-5802-25  
25.5 cm/10"



CARDIOVASCULAR

ATRAUMA



POTTS



BI 19-5803-21  
 21.5 cm/8 1/2"



BI 19-5803-23  
 23.5 cm/9 1/4"



BI 19-5803-27  
 27 cm/10 1/2"



BI 19-5803-31  
 31.5 cm/12 3/8"



POTTS



BI 19-5804-21  
 21 cm/8 1/4"



BI 19-5804-23  
 23 cm/9"



BI 19-5804-26  
 26 cm/10 1/4"



BI 19-5804-31  
 31 cm/12 1/4"



ATRAUMA



DEBAKEY

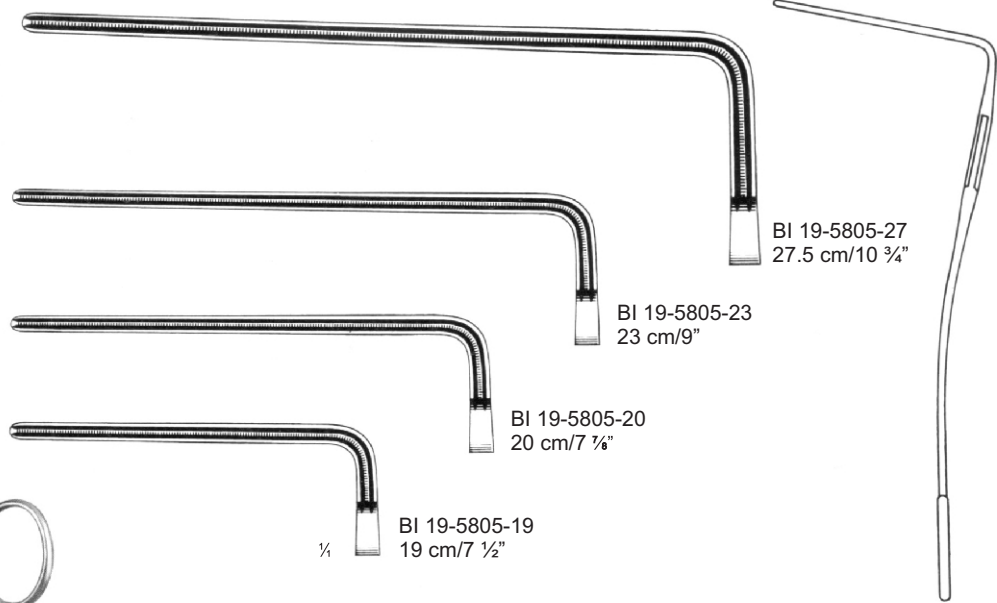

DEBAKEY

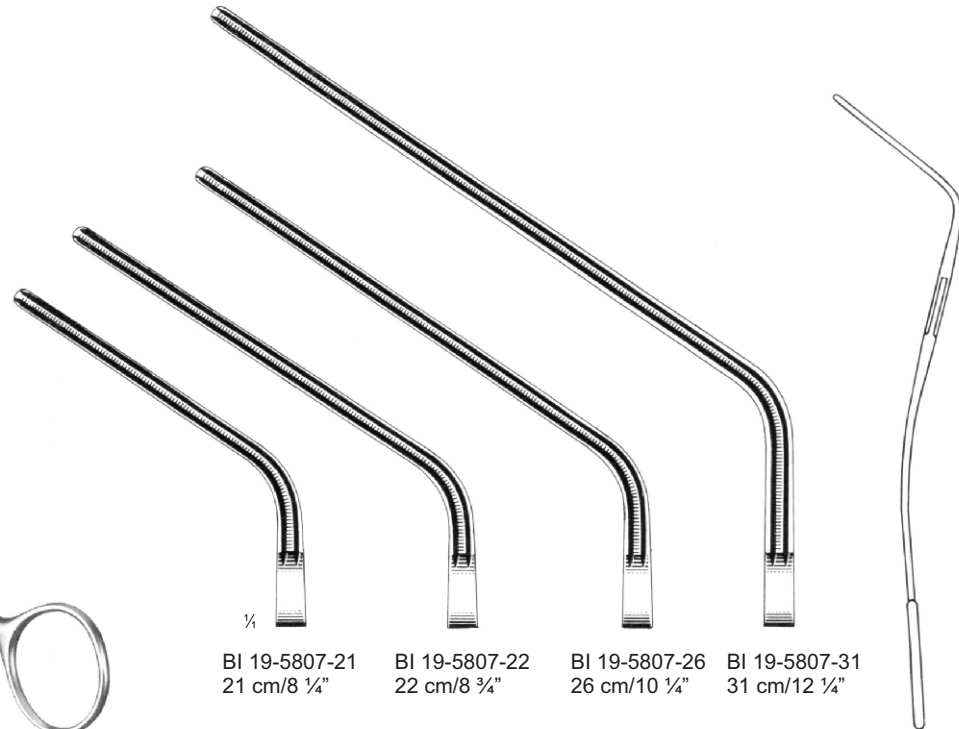

ATRAUMA

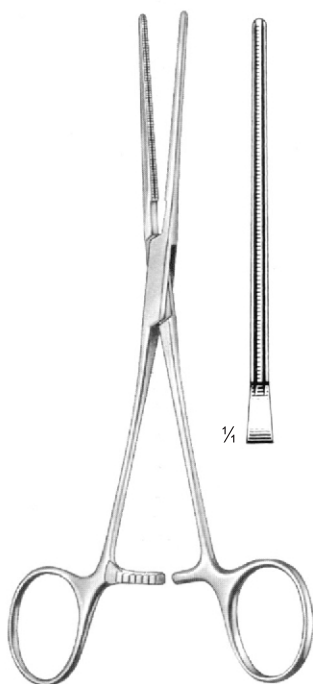

**DEBAKEY**  
 BI 19-5808-17  
 17 cm/6 3/4"

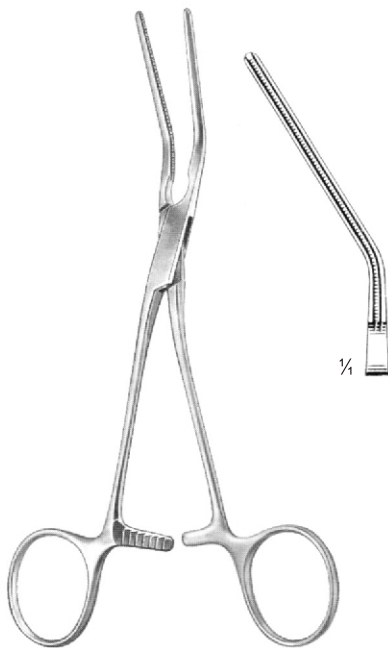

**DEBAKEY**  
 BI 19-5809-16  
 16.5 cm/6 1/2"

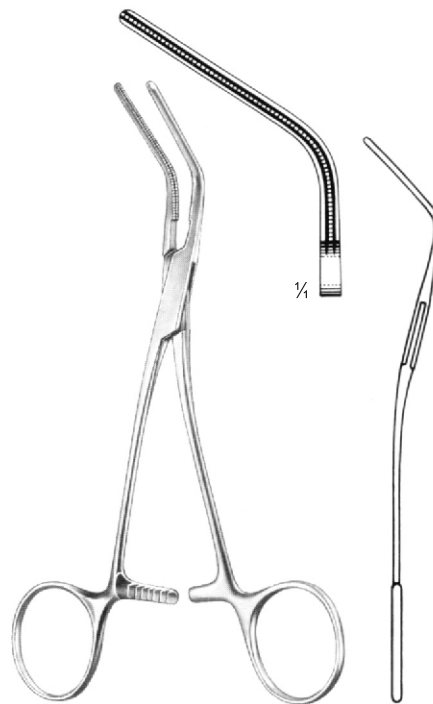

**DEBAKEY**  
 BI 19-5810-16  
 16 cm/6 1/4"

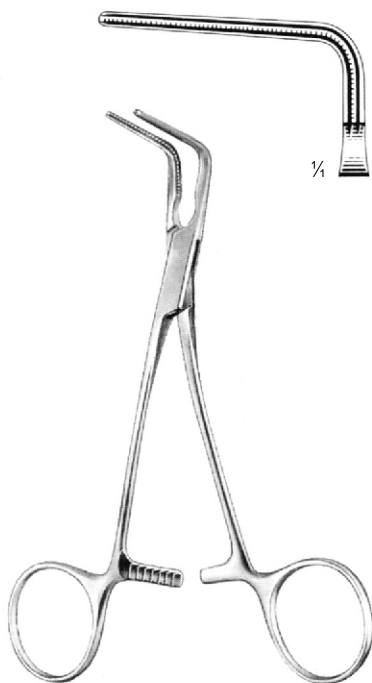

**DEBAKEY**  
 BI 19-5811-14  
 14.5 cm/5 3/4"

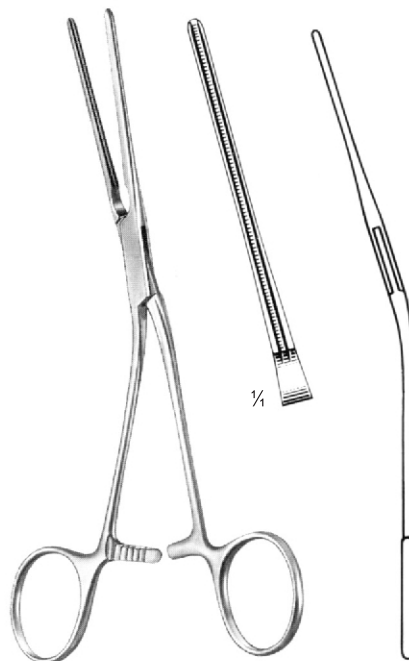

**DEBAKEY**  
 BI 19-5812-16  
 16.5 cm/6 1/2"



ATRAUMA

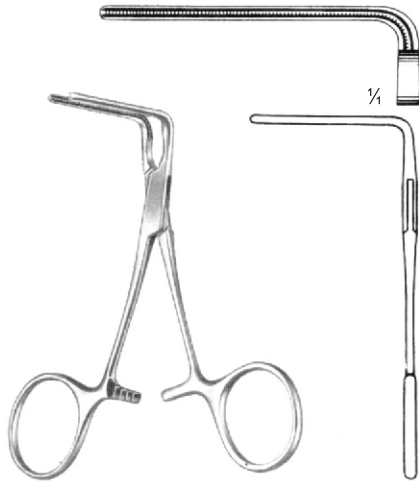

**DEBAKEY**  
BI 19-5813-10  
10 cm/3 7/8"



**DEBAKEY**  
BI 19-5814-12  
12.5 cm/4 7/8"

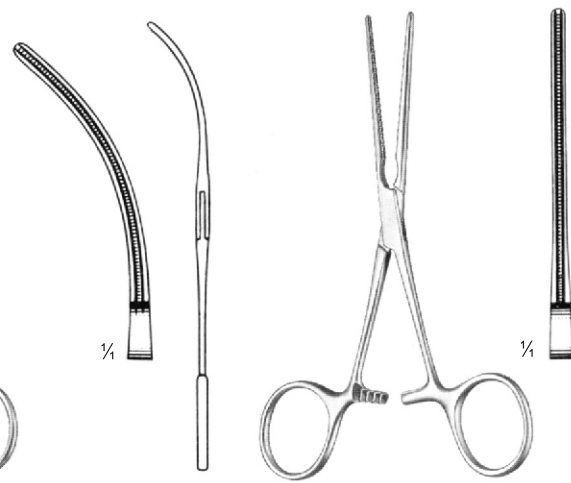

**DEBAKEY**  
BI 19-5815-13  
13 cm/5 1/8"

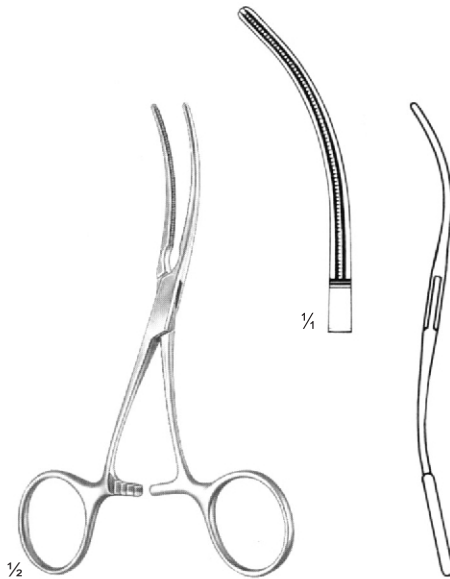

**DEBAKEY**  
BI 19-5816-12  
12.5 cm/4 7/8"

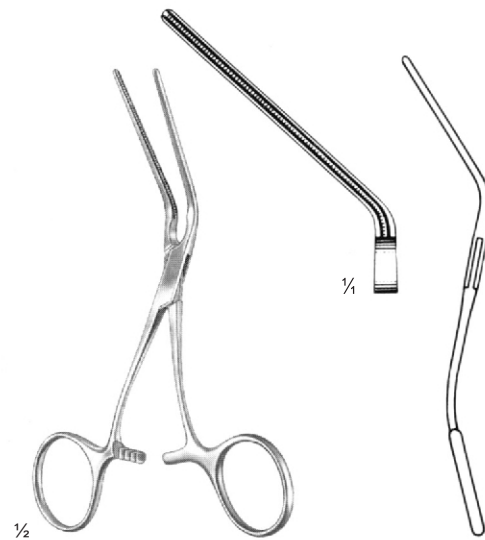

**DEBAKEY**  
BI 19-5817-12  
12.5 cm/4 7/8"

ATRAUMA

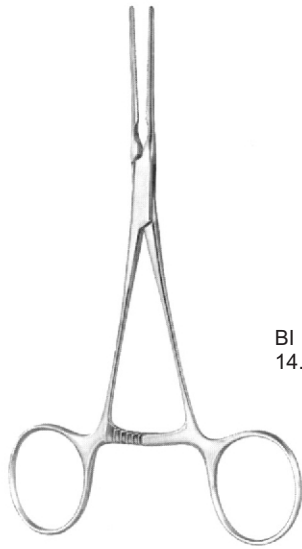

BI 19-5818-14  
 14.5 cm/5 3/4"

COOLEY

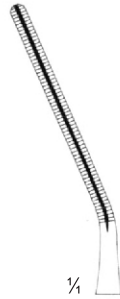

BI 19-5819-14  
 14.5 cm/5 3/4"



COOLEY  
 BI 19-5820-14  
 14 cm/5 1/2"

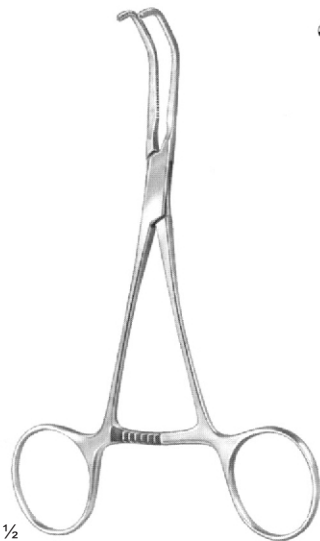

COOLEY  
 BI 19-5821-14  
 14 cm/5 1/2"



COOLEY  
 BI 19-5822-14  
 14.5 cm/5 3/4"





**ATRAUMA**

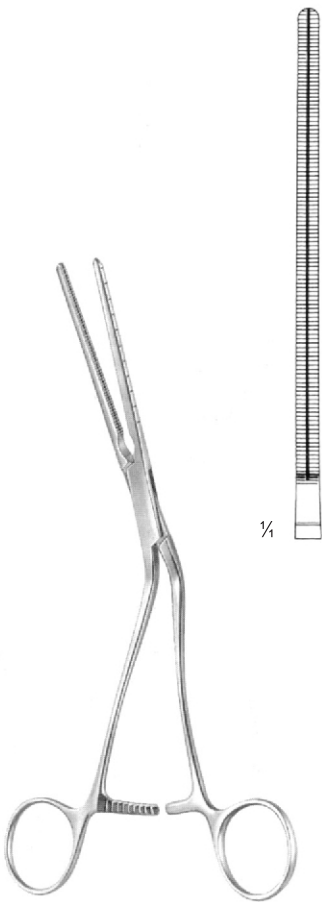

**COOLEY**  
BI 19-5823-22 22 cm/8 3/4"  
BI 19-5823-25 25 cm/12"  
Liac Clamp

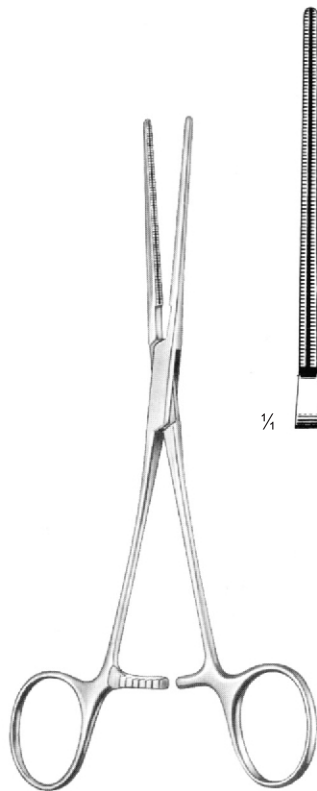

**COOLEY**  
BI 19-5824-17  
17 cm/6 3/4"

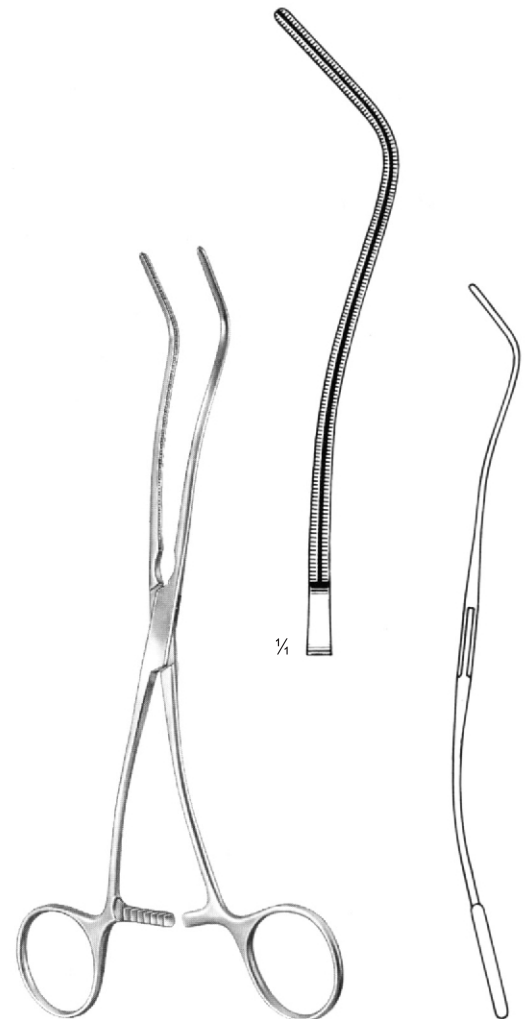

**COOLEY**  
BI 19-5825-20  
20 cm/7 7/8"  
Carotid Clamps

Cardiovascular Surgery

ATRAUMA

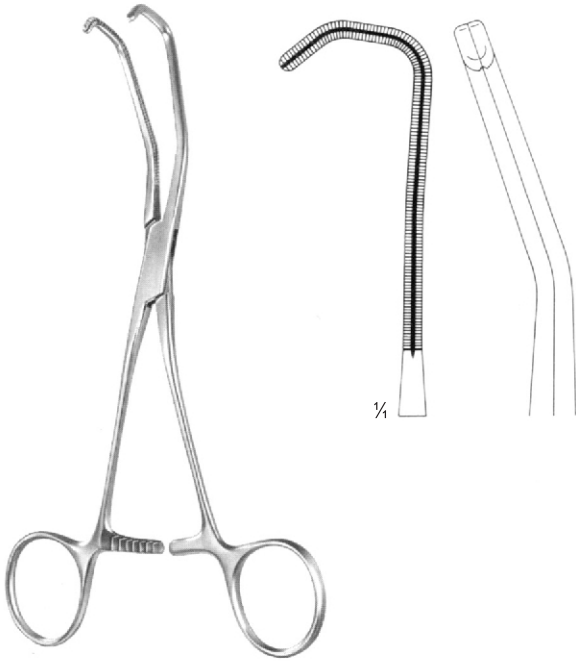

**COOLEY**  
 BI 19-5826-17  
 17 cm/6 3/4"

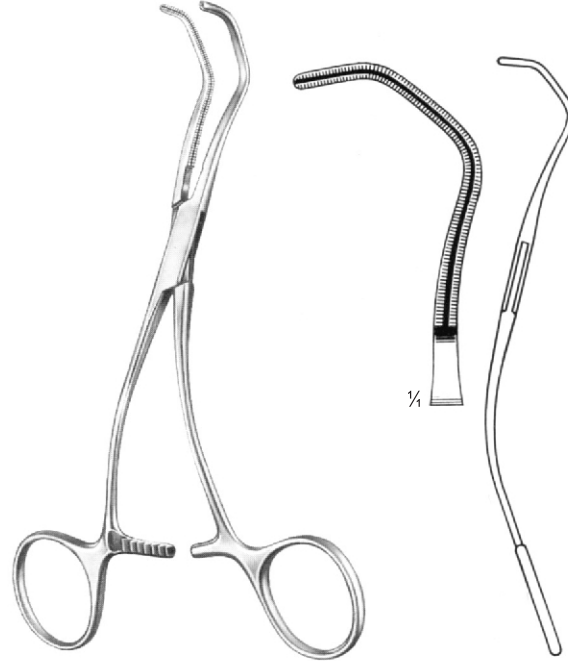

**COOLEY**  
 BI 19-5827-16  
 16 cm/6 1/4"



**COOLEY**  
 BI 19-5828-14  
 14 cm/5 1/2"

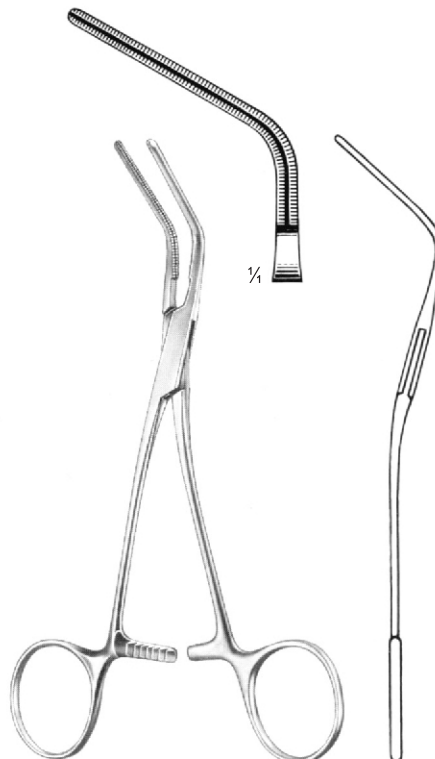

**COOLEY**  
 BI 19-5829-16  
 16 cm/6 1/4"

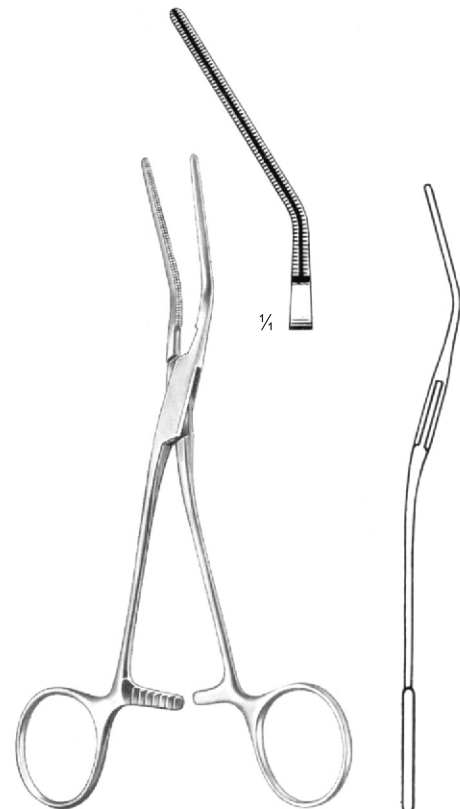

**COOLEY**  
 BI 19-5830-16  
 16.5 cm/6 1/2"





**ATRAUMA**



**COOLEY**  
BI 19-5831-17  
17 cm/6 3/4"

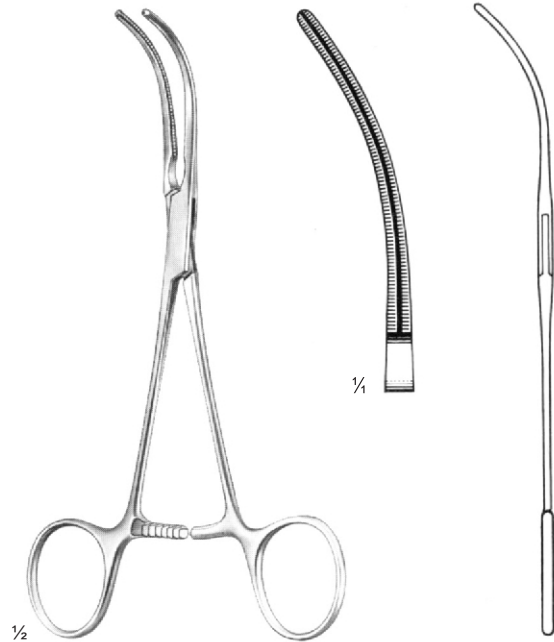

**COOLEY**  
BI 19-5832-17  
17 cm/6 3/4"

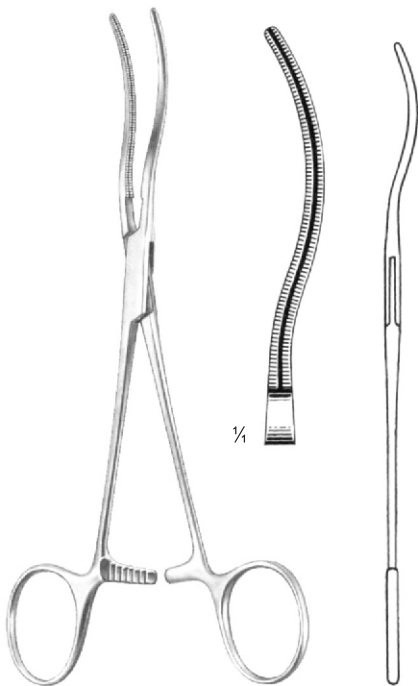

**COOLEY**  
BI 19-5833-17  
17.5 cm/6 7/8"

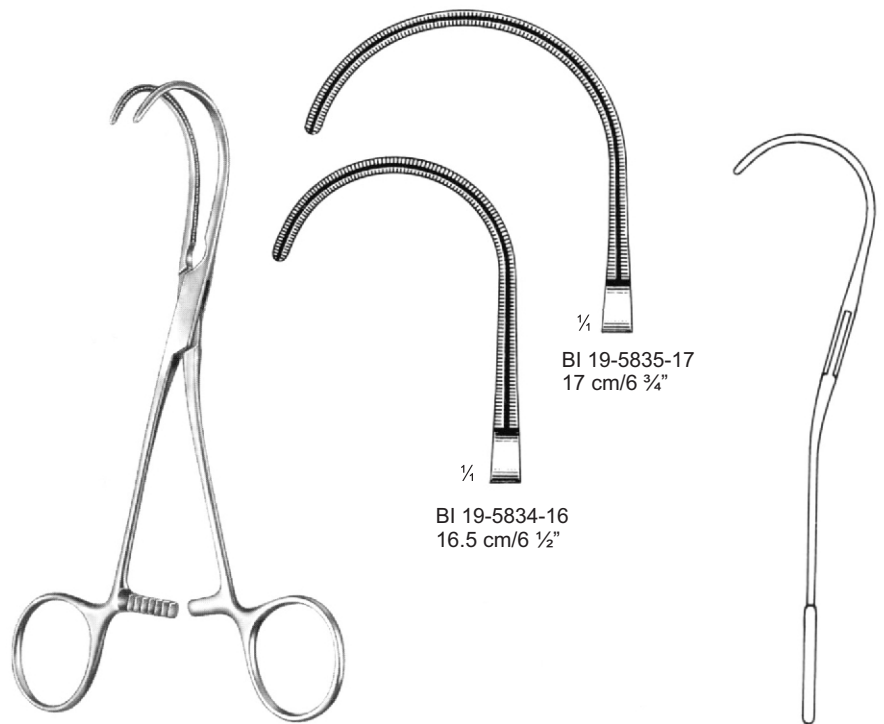

**COOLEY**  
BI 19-5834-16  
16.5 cm/6 1/2"

BI 19-5835-17  
17 cm/6 3/4"





**ATRAUMA**



**COOLEY-DERRA**



BI 19-5836-16  
 16.5 cm/6 1/2"

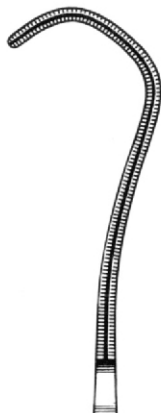

BI 19-5837-17  
 17 cm/6 3/4"

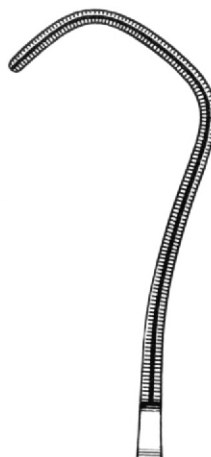

BI 19-5838-18  
 17.5 cm/6 7/8"



**COOLEY-BECK**  
 BI 19-5839-17  
 17 cm/6 3/4"

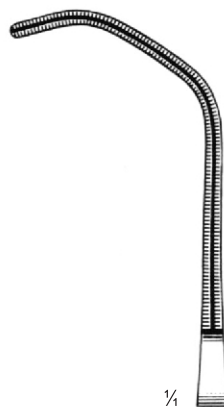

1/4



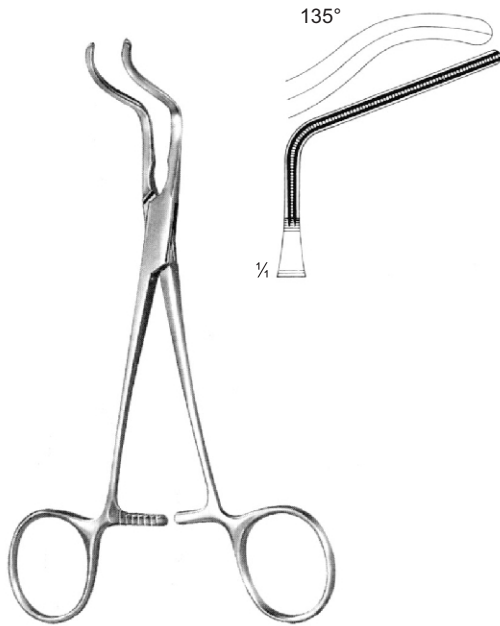

**SUBRAMANIAN-MINIATURE**

BI 19-5840-15  
15.5 cm/6 1/8"

**ATRAUMA**

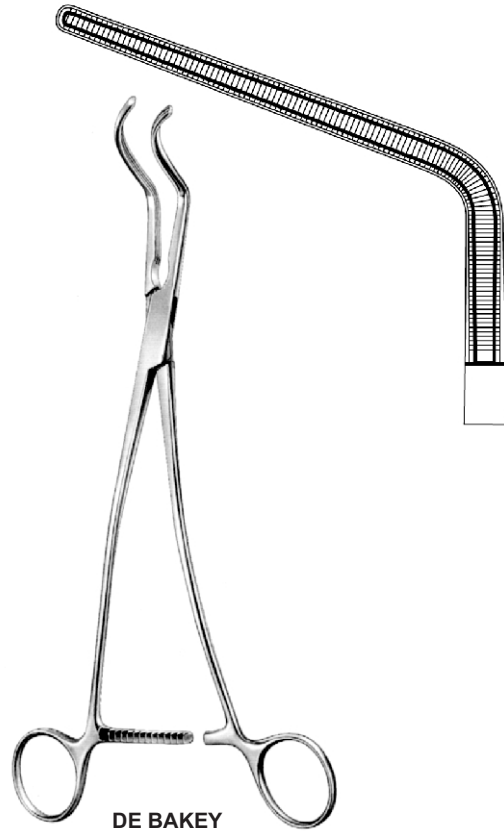

**DE BAKEY**

BI 19-5840-27  
27.0cm

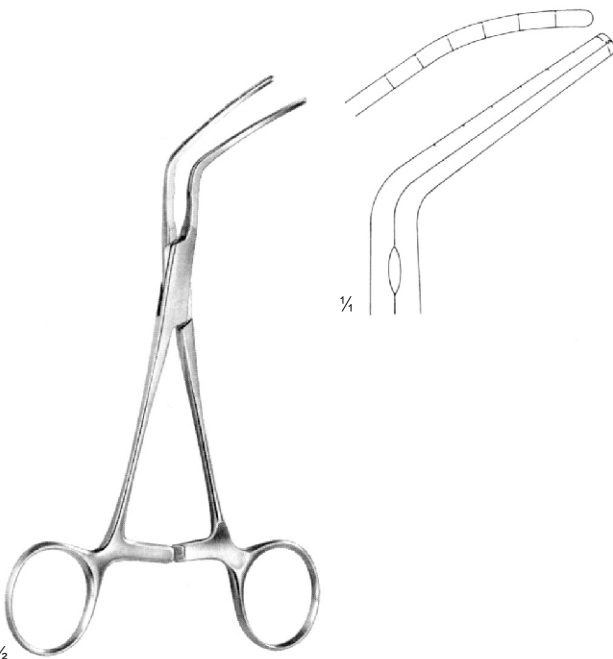

**SUBRAMANIAN**

BI 19-5841-16  
16 cm/6 1/4"

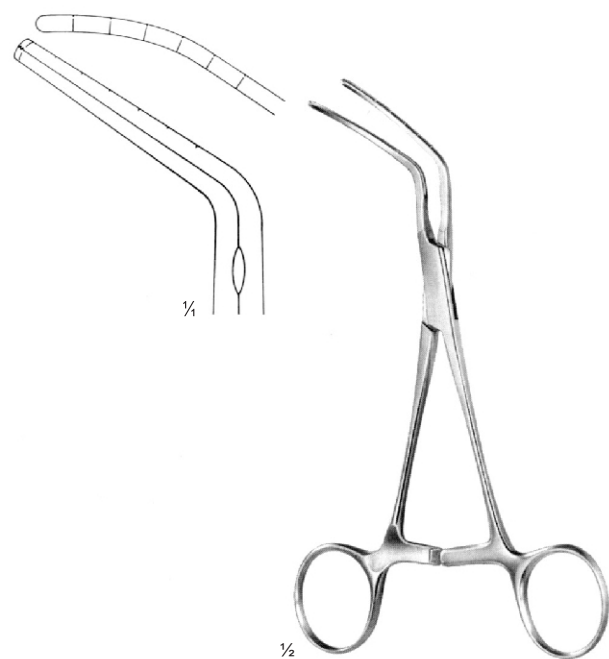

**SUBRAMANIAN**

BI 19-5842-16  
16 cm/6 1/4"

Pediatric Vascular Clamps  
 Kinder-Gefäßklemmen  
 Pinzas vasculares pediátricas  
 Pinces à anastomose  
 Pinze per anastomosi

EN  
 DE  
 ES  
 FR  
 IT

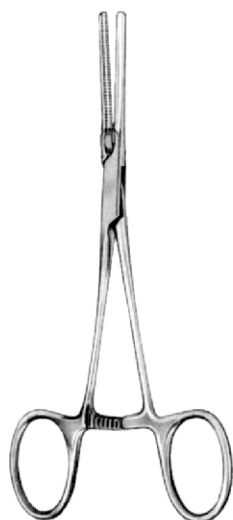
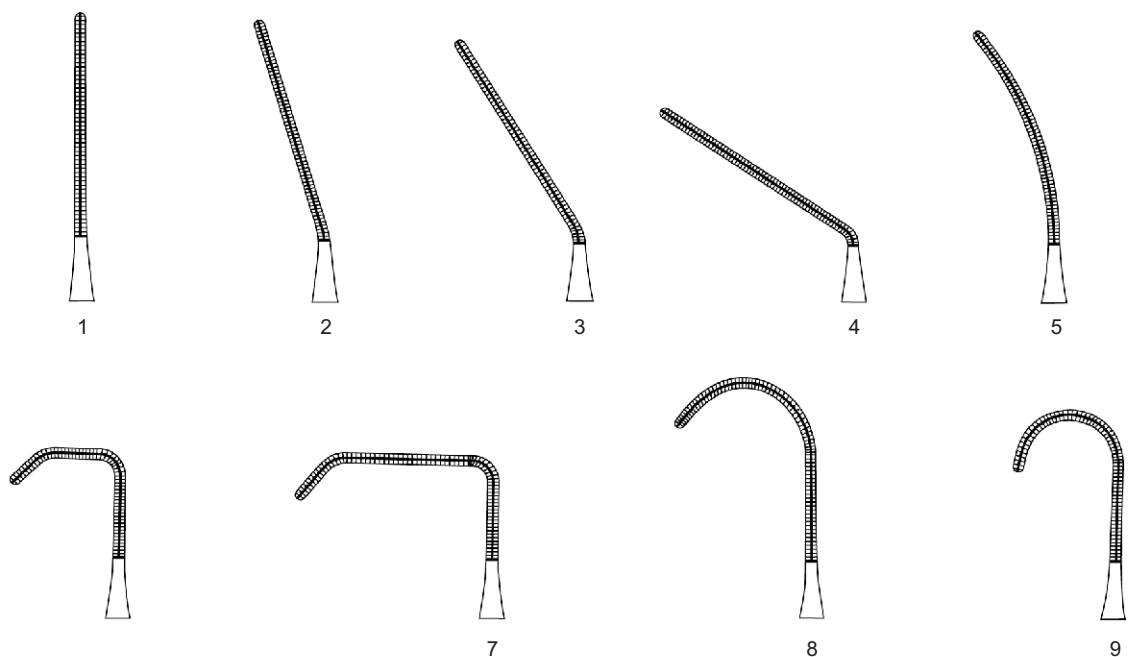

- 1 BI 19-5843-01 14.5cm
- 2 BI 19-5843-02 14.5cm
- 3 BI 19-5843-03 14.5cm
- 4 BI 19-5843-04 13.5cm
- 5 BI 19-5843-05 14.0cm
- 6 BI 19-5843-06 13.5cm
- 7 BI 19-5843-07 13.5cm
- 8 BI 19-5843-08 14.0cm
- 9 BI 19-5843-09 13.5cm

- 1 BI 19-5843-11 14.5cm
- 2 BI 19-5843-12 14.5cm
- 3 BI 19-5843-13 14.5cm
- 4 BI 19-5843-14 13.5cm
- 5 BI 19-5843-15 14.0cm
- 6 BI 19-5843-16 13.5cm
- 7 BI 19-5843-17 13.5cm
- 8 BI 19-5843-18 14.0cm
- 9 BI 19-5843-19 13.5cm

- 1 BI 19-5843-21 14.5cm
- 2 BI 19-5843-22 14.5cm
- 3 BI 19-5843-23 14.5cm
- 4 BI 19-5843-24 13.5cm
- 5 BI 19-5843-25 14.0cm
- 6 BI 19-5843-26 13.5cm
- 7 BI 19-5843-27 13.5cm
- 8 BI 19-5843-28 14.0cm
- 9 BI 19-5843-29 13.5cm



ATRAUMA

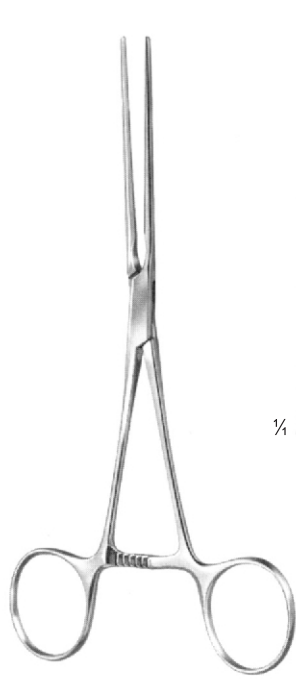

**COOLEY**  
BI 19-5844-16  
16.5 cm/6 1/2"

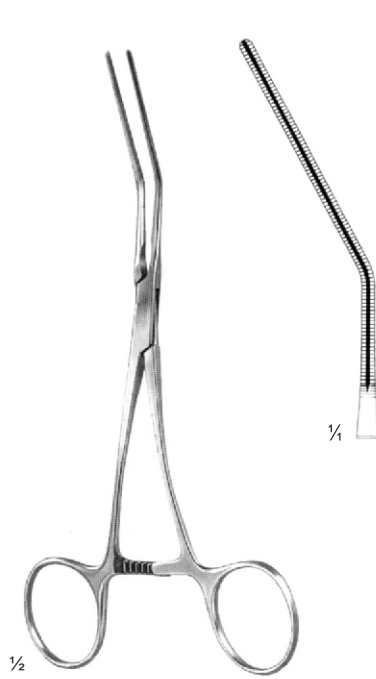

**COOLEY**  
BI 19-5845-16  
16 cm/6 1/4"



**COOLEY**  
BI 19-5846-15  
15.5 cm/6 1/8"

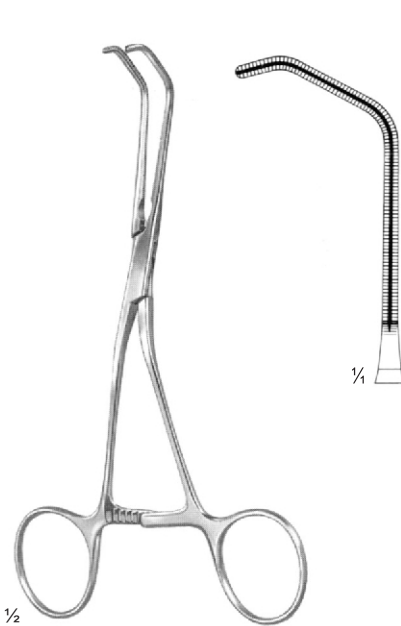

**COOLEY**  
BI 19-5847-15  
15.5 cm/6 1/8"

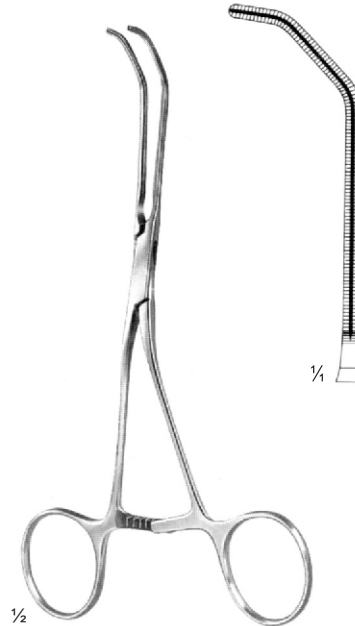

**COOLEY**  
BI 19-5848-16  
16 cm/6 1/4"

**ATRAUMA**

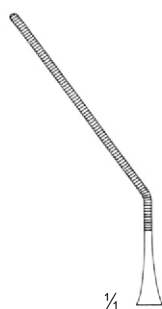

BI 19-5849-01  
 12.5 cm/4 7/8"

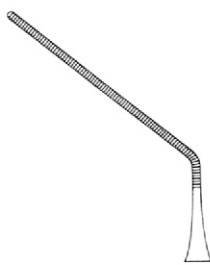

BI 19-5849-02  
 11.5 cm/4 1/2"



BI 19-5849-03  
 11 cm/4 3/8"



**CASTANEDA**

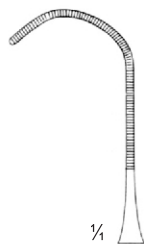

BI 19-5849-04  
 11.5 cm/4 1/2"

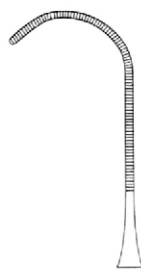

BI 19-5849-05  
 12 cm/4 3/4"

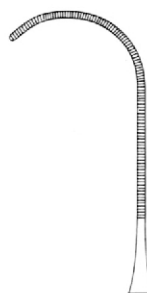

BI 19-5849-06  
 12 cm/4 3/4"



BI 19-5849-07  
 12 cm/4 3/4"





**ATRAUMA**

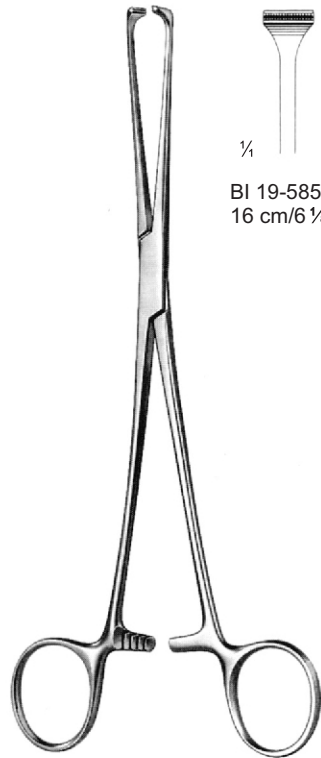

**ALLIS**

¼

BI 19-5850-16  
16 cm/6 ½"

BI 19-5850-20  
20 cm/7 7/8"

BI 19-5850-25  
25 cm/10"

BI 19-5850-30  
30 cm/11 ¾"

**ATRAUMA**



**DUVAL**

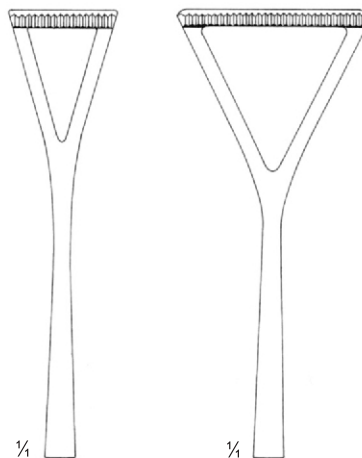

13 mm		25 mm
BI 19-5851-18	18 cm	BI 19-5852-18
BI 19-5851-20	20 cm	BI 19-5852-20
BI 19-5851-23	23 cm	BI 19-5852-23





**ATRAUMA**



BI 19-5853-25  
25 cm/9 7/8"



BI 19-5853-26  
26 cm/10 1/4"



**SCHEIBE**



1/4  
BI 19-5854-18  
18 cm/7 1/8"  
narrow



1/4  
BI 19-5854-20  
20.5 cm/8 1/8"  
medium



1/4  
BI 19-5854-23  
23 cm/9"  
wide



**ATRAUMA**



**DOYEN-ATRAUMA**

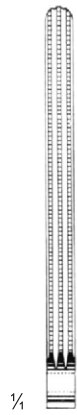

BI 19-5855-14  
 14 cm/5 1/2"

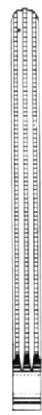

BI 19-5855-16  
 16 cm/6 3/4"

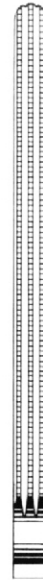

BI 19-5855-18  
 18.5 cm/7 1/4"



BI 19-5855-21  
 21.5 cm/8 1/2"

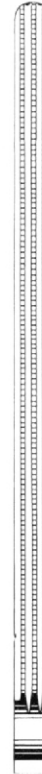

BI 19-5855-23  
 23.5 cm/9 1/4"

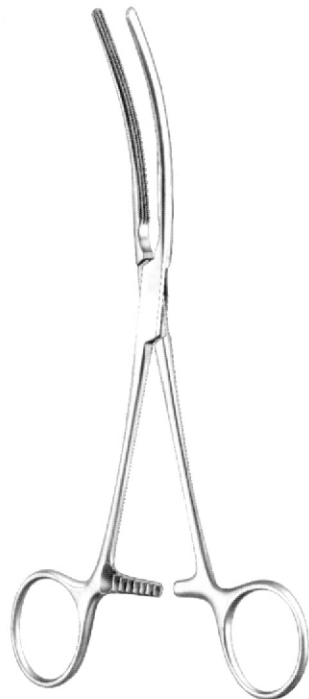

**DOYEN-ATRAUMA**

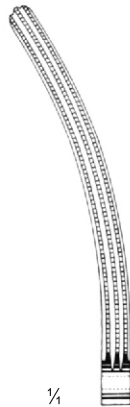

BI 19-5856-13  
 13.5 cm/5 3/8"

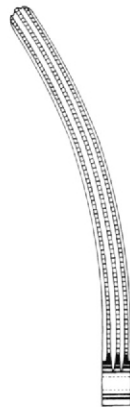

BI 19-5856-16  
 16 cm/6 3/4"



BI 19-5856-18  
 18 cm/7 1/8"

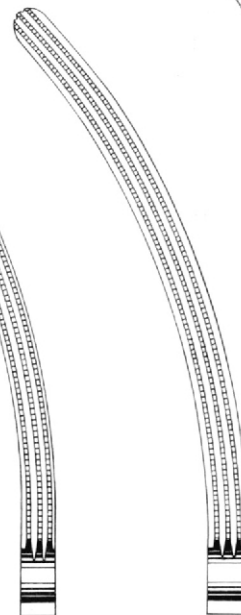

BI 19-5856-21  
 21 cm/8 1/4"



BI 19-5856-23  
 23 cm/9"





**ATRAUMA**



**HAYES**

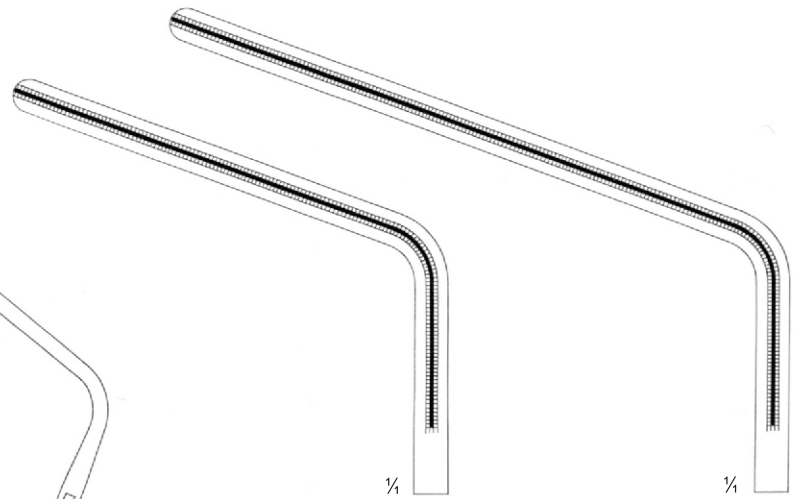
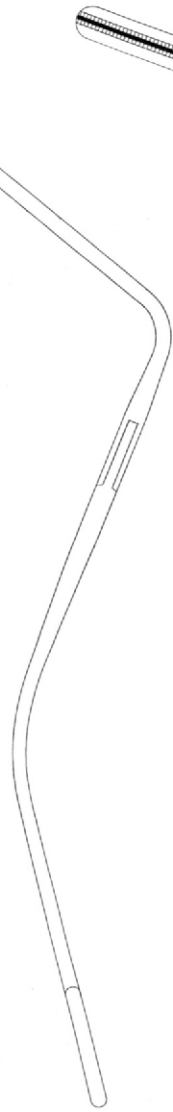

BI 19-5857-26  
26 cm/10 1/2"

BI 19-5857-28  
28 cm/11"

Sigmoid Anastomosis Forceps ● EN  
 Rektum-Anastomosenklemmen ● DE  
 Pinzas para anastomosis rectales ● ES  
 Pince à anastomose sigmoïde ● FR  
 Pinza per anastomosi sigmoidea ● IT

ATRAUMA

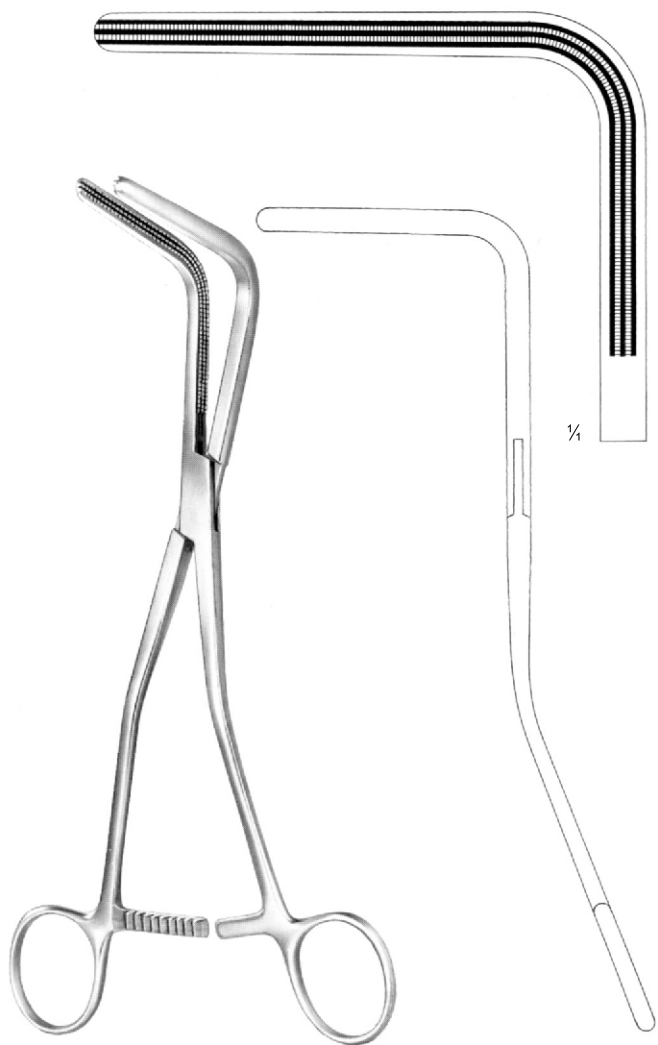

**VEIDENHEIMER**  
 BI 19-5858-25  
 25 cm/9 7/8"



**FEHLAND**  
 BI 19-5859-24  
 24 cm/9 1/2"



**ATRAUMA**



**RESANO**  
BI 19-5860-30  
30 cm/12"